

PT3000PSIG-2121-I2-DT043P

Pressure Transmitter – With Current Output (2-Wire)

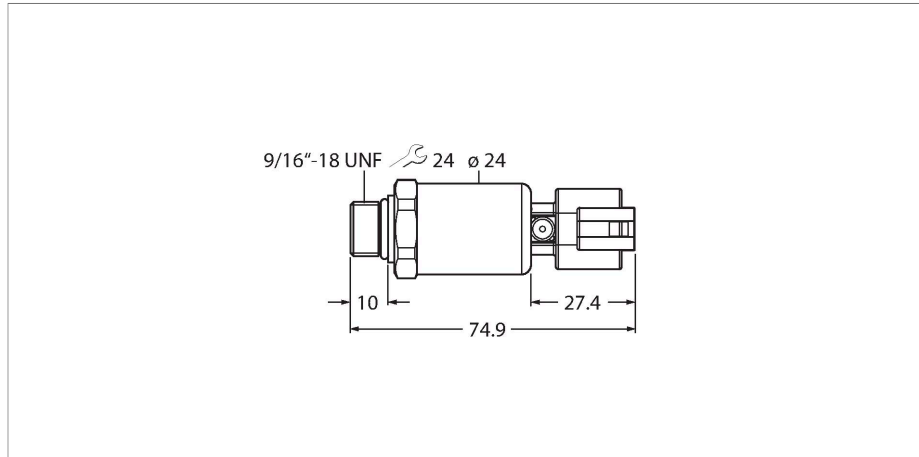

Features

- For mobile hydraulic applications
- Fully welded metal measuring cell
- Sealless
- With pressure tip orifice
- Compact and robust design
- Excellent EMC properties
- Excellent accuracy and long-term stability
- Kfz-Norm ISO 16750
- Pressure range 0...3000 psi rel.
- 7.5...33 VDC
- Analog output 4...20 mA
- Process connection 9/16"-18 UNF (SAE) male thread
- Plug-in device, Deutsch DT04-3P

Technical data

Type	PT3000PSIG-2121-I2-DT043P
ID	100002007
Medium temperature	-40...+125 °C
Pressure type	Relative pressure
Pressure range	0...206.84 bar
	0...3000 psi
	0...20.68 MPa
Admissible overpressure	≤ 750 bar
Burst pressure	≥ 1500 bar
Response time	< 2 ms, typ. 1 ms
Long-term stability	± 0.3 % FS, acc. to IEC EN 61298-2
Power supply	
Operating voltage U_s	7.5...33 VDC
Current consumption	≤ 23 mA
Short-circuit/reverse polarity protection	yes / yes
Insulation class	III
Outputs	
Output 1	Analog output
Output function	Analog output current
Analog output	
Current output	4...20 mA
Load	≤ (supply voltage - 7.5)/20 kΩ
Accuracy LHR	±0.5 % FS (under EMC interference max. ±1.5 % FS)

Wiring diagram

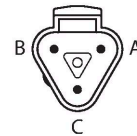
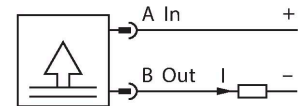

Functional principle

The pressure sensors in the PT...-2100 product series are designed specifically for demanding mobile hydraulic applications. They operate with a fully welded metal measuring cell in different pressure ranges of up to 0...600 bar in 2- or 3-wire technology. Depending on the sensor variant, the processed signal is available as an analog output (4...20 mA, 0...10 V, 0...5 V, ratiometric). A wide range of process connections and electrical connections offer a high degree of flexibility in many different applications.

Technical data

Mechanical data	
Housing material	Stainless-steel/Plastic, 1.4404 (AISI 316L)/polyarylamide 50 % GF UL 94 V-0
Process connection	9/16"-18 UNF male thread
Pressure connection material	Stainless steel 1.4404 (AISI 316L)
Material pressure transducer	Stainless steel 1.4404 (AISI 316L)
Wrench size pressure connection / coupling nut	24
Max. tightening torque of housing nut	20 Nm
Electrical connection	Connector, Deutsch DT04-3P
Protection class	IP69K
Environmental conditions	
Ambient temperature	-40...+100 °C
Storage temperature	-50...+100 °C
Shock resistance	50 g, 11 ms, half sine curve, 1000x/axis acc. to ISO 16750-3
Vibration resistance	Test VI (12 g, sinusoidal 18 g random vibration)
EMV	Interference Immunity/Interference Emission EN 61326-2-3 - Pressure transducer ISO 13766 - Earthmoving machinery DIN EN 13309 - Construction machinery DIN ISO 14982 - Forestry and agriculture CISPR11 Immunity Motor Vehicle Directive ISO 11452-2, HF (Field), 100 V/m (200...2000 MHz) ISO 11452-4, HF (BCI), 100 mA (20...400 MHz) ISO 10605, ESD, ±15 kV contact, ±15 kV air ISO 7637-2 3), pulses 1, 2a, 2b, 3a, 3b (test level 4) ISO 16750-2, load dump, 155 V (1 Ω, 300 ms) Motor vehicle directive ECE R10 Motor vehicle directive 2004/104/EC
Tests/approvals	
Reference conditions acc. to IEC 61298-1	
Temperature	15...+25 °C
Atmospheric pressure	860...1060 hPa abs.
Humidity	45 % rel.
Auxiliary power	24 VDC

Technical data

Temperature behaviour	
MTTF	1189 years acc. to SN 29500 (Ed. 99) 40 °C
Included in delivery	FKM O-ring special (1 pc)

Technical data

Type	PT3000PSIG-2121-I2-DT043P
ID	100002007
Pressure type	Relative pressure
Pressure range	0...206.84 bar
	0...3000 psi
	0...20.68 MPa
Admissible overpressure	≤ 750 bar
Burst pressure	≥ 1500 bar
Response time	< 2 ms, typ. 1 ms
Long-term stability	0.3 % FS, acc. to IEC EN 61298-2

Power supply	
Operating voltage U_s	7.5...33 VDC
Current consumption	≤ 23 mA
Short-circuit/reverse polarity protection	yes / yes
Protection class	IP69K
Insulation class	III
Insulation voltage	500 VDC

Outputs	
Output 1	Analog output
Output function	Analog output current

Analog output	
Current output	4...20 mA
Load	≤ (supply voltage - 7.5)/20 kΩ
Accuracy LHR	±0.5 % FS (under EMC interference max. ±1.5 % FS)

Temperature behaviour	
Medium temperature	-40...+125 °C
Temperature coefficient	± 0.2 % of full scale/10 K

Environmental conditions	
Ambient temperature	-40...+100 °C
Storage temperature	-50...+100 °C
Vibration resistance	Test VI (12 g, sinusoidal 18 g random vibration)

Technical data

Shock resistance	50 g, 11 ms, half sine curve, 1000x/ axis acc. to ISO 16750-3
EMV	Interference Immunity/Interference Emission EN 61326-2-3 - Pressure transducer ISO 13766 - Earthmoving machinery DIN EN 13309 - Construction machinery DIN ISO 14982 - Forestry and agriculture CISPR11 Immunity Motor Vehicle Directive ISO 11452-2, HF (Field), 100 V/m (200... 2000 MHz) ISO 11452-4, HF (BCI), 100 mA (20... 400 MHz) ISO 10605, ESD, ±15 kV contact, ±15 kV air ISO 7637-2 3), pulses 1, 2a, 2b, 3a, 3b (test level 4) ISO 16750-2, load dump, 155 V (1 Ω, 300 ms) Motor vehicle directive ECE R10 Motor vehicle directive 2004/104/EC
Mechanical data	
Housing material	Stainless-steel/Plastic, 1.4404 (AISI 316L)/polyarylamide 50 % GF UL 94 V-0
Pressure connection material	Stainless steel 1.4404 (AISI 316L)
Material pressure transducer	Stainless steel 1.4404 (AISI 316L)
Process connection	9/16"-18 UNF male thread
Wrench size pressure connection / coupling nut	24
Electrical connection	Connector, Deutsch DT04-3P
Max. tightening torque of housing nut	20 Nm
Reference conditions acc. to IEC 61298-1	
Temperature	15...+25 °C
Atmospheric pressure	860...1060 hPa abs.
Humidity	45 % rel.
Auxiliary power	24 VDC
Tests/approvals	
MTTF	1189 years acc. to SN 29500 (Ed. 99) 40 °C
Included in delivery	FKM O-ring special (1 pc)