

# NI8-S18-VP4X

## Inductive Sensor

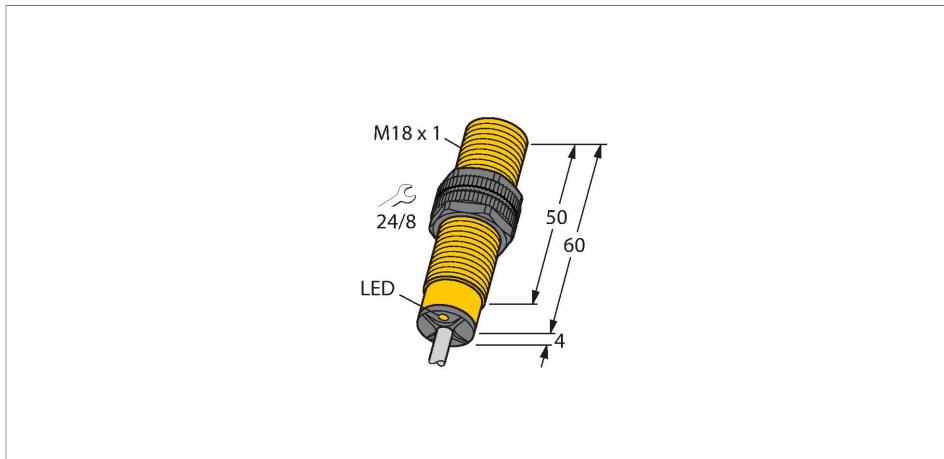

### Features

- Threaded barrel, M18 x 1
- Plastic, PA12-GF30
- DC 4-wire, 10...65 VDC
- Changeover contact, PNP output
- Cable connection

### Wiring diagram

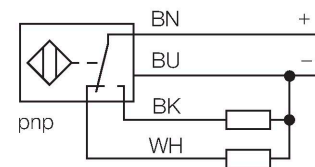

### Technical data

Type	NI8-S18-VP4X
ID	15135
<b>General data</b>	
Rated switching distance	8 mm
Mounting conditions	Non-flush
Secured operating distance	$\leq (0.81 \times S_n)$ mm
Correction factors	St37 = 1; Al = 0.3; stainless steel = 0.7; Ms = 0.4
Repeat accuracy	$\leq 2$ % of full scale
Temperature drift	$\leq \pm 10$ %
Hysteresis	3...15 %
<b>Electrical data</b>	
Operating voltage $U_b$	10...65 VDC
Ripple $U_{rs}$	$\leq 10$ % $U_{Bmax}$
DC rated operating current $I_o$	$\leq 200$ mA
No-load current	$\leq 15$ mA
Residual current	$\leq 0.1$ mA
Isolation test voltage	0.5 kV
Short-circuit protection	yes/Cyclic
Voltage drop at $I_o$	$\leq 1.8$ V
Wire break/reverse polarity protection	yes/Complete
Output function	4-wire, Complementary contact, PNP
Switching frequency	0.5 kHz

### Functional principle

Inductive sensors detect metal objects contactless and wear-free. For this, they use a high-frequency electromagnetic AC field that interacts with the target. Inductive sensors generate this field via an RLC circuit with a ferrite coil.

## Technical data

Mechanical data	
Design	Threaded barrel, M18 x 1
Dimensions	64 mm
Housing material	Plastic, PA12-GF30
Active area material	Plastic, PA12-GF30
End cap	Plastic, EPTR
Max. tightening torque of housing nut	2 Nm
Electrical connection	Cable
Cable quality	Ø 5.2 mm, Gray, LifYY, PVC, 2 m
Core cross-section	4 x 0.34 mm <sup>2</sup>
Environmental conditions	
Ambient temperature	-25...+70 °C
Vibration resistance	55 Hz (1 mm)
Shock resistance	30 g (11 ms)
Protection class	IP67
MTTF	2283 years acc. to SN 29500 (Ed. 99) 40 °C
Switching state	LED, Yellow

## Mounting instructions

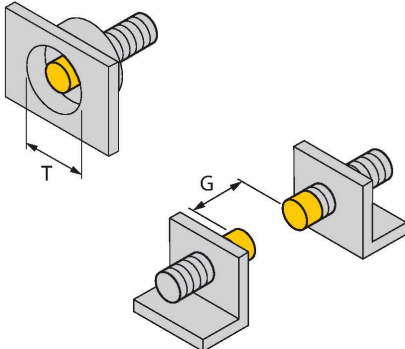
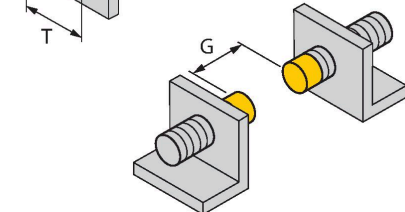
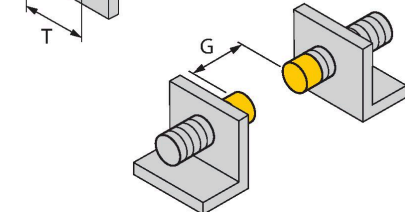
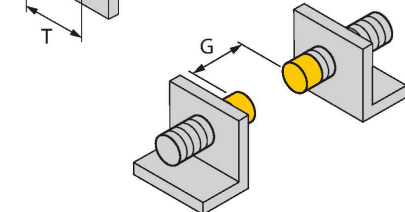
Mounting instructions/Description		
	Distance D	3 x B
	Distance W	3 x Sn
	Distance T	3 x B
	Distance S	1.5 x B
	Distance G	6 x Sn
	Distance N	2 x Sn
	Diameter active area B	Ø 18 mm

## Accessories

QM-18

6945102

Quick-mount bracket with dead-stop; material: Chrome-plated brass. Male thread M24 × 1.5. Note: The switching distance of the proximity switches may change when using quick-mount brackets.



BST-18B

6947214

Mounting clamp for threaded barrel sensors, with dead-stop; material: PA6

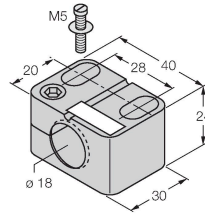

MW18

6945004

Mounting bracket for threaded barrel sensors; material: Stainless steel A2 1.4301 (AISI 304)



BSS-18

6901320

Mounting clamp for smooth and threaded barrel sensors; material: Polypropylene

