

BL compact™ multiprotocol fieldbus station for Industrial Ethernet

RS232 Interface and 8 Configurable Digital PNP Channels

BLCEN-5M12LT-1RS232-8XSG-P

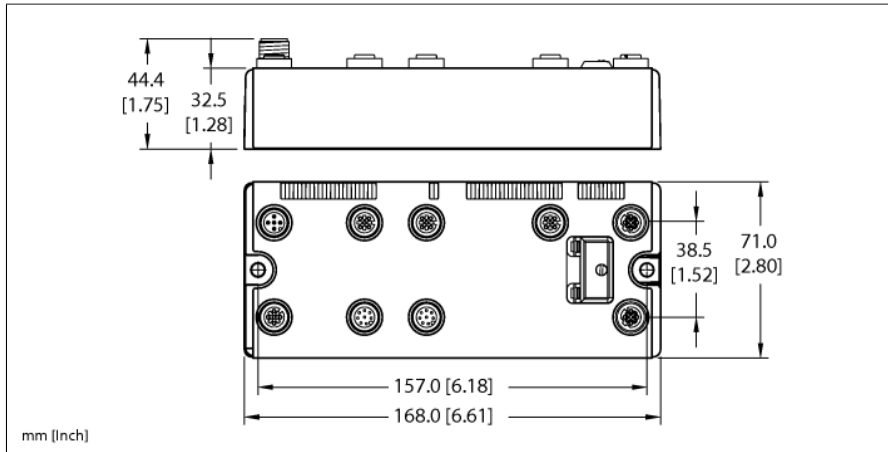

ID	6811509
Nominal system voltage	24 VDC
System power supply	Via auxiliary power
Voltage supply connection	2 x M12, 5-pin
Admissible range Vi	18...30 VDC
Nominal current Vi	275 mA
Max. current Vi	2 A
Admissible range Vo	18...30 VDC
Nominal current Vo	100 mA
Max. current Vo	4 A
Electrical isolation	The inputs and outputs of the 8XSG I/O cards are supplied via a common ground. Therefore, it is recommended not to use this module for safety or emergency stop applications.
Fieldbus transmission rate	10/100 Mbps
Adjustment transmission rate	Automatic detection
Fieldbus address range	1...92 0 (192.168.1.254) 93 (BOOTP) 94 (DHCP) 95 (PGM) 96 (PGM-DHCP) *recommended for PROFINET 97...98 (manufacturer specific)
Fieldbus addressing	2 decimally coded rotary switches
Fieldbus connection technology	2 x M12 4-pole, D-coded
Protocol detection	automatic
Web server	Integrated
Service interface	Ethernet
Vendor ID	48
Product type	12
Product code	11509

- On-machine Compact fieldbus I/O block
- EtherNet/IP™, Modbus® TCP, or PROFINET slave
- Integrated Ethernet Switch
- 10 Mbps / 100 Mbps supported
- Two 4-pole M12, D-coded, connectors for fieldbus connection
- 2 rotary switches for node address
- IP67, IP69K
- M12 I/O connectors
- LEDs indicating status and diagnostics
- Electronics galvanically separated from the field level via optocouplers
- 8 Configurable digital PNP channels, 24 VDC
- Max. 0.5A per channel
- Selection of filtering times (Input delay)
- Invertible inputs
- Transmission of serial data via RS232 interface
- For connection of devices such as: printers, scanners, or bar code readers

Modbus TCP	
Addressing	Static IP, BOOTP, DHCP
Supported function codes	FC1, FC2, FC3, FC4, FC5, FC6, FC15, FC16, FC23
Number of TCP connections	6
Input Data Size	max. 7 register
Input register start address	0 (0x0000 hex)
Output Data Size	max. 5 register
Output register start address	2048 (0x0800 hex)

Ethernet/IP	
Addressing	acc. to EtherNet/IP specification
Device Level Ring (DLR)	supported
Class 1 connections (CIP)	6
Input Assembly Instance	103
Input Data Size	7 INT
Output Assembly Instance	104
Output Data Size	5 INT
Configuration Assembly Instance	106
Configuration Size	0
Comm Format	Data - INT

PROFINET	
Addressing	DCP
Conformance class	B (RT)
MinCycleTime	1 ms
Diagnostics	acc. to PROFINET alarm handling
Topology detection	supported
Automatic addressing	supported
Media Redundancy Protocol (MRP)	supported
Input Data Size	max. 10 BYTE
Output Data Size	max. 10 BYTE

Digital inputs	
Input type	PNP
Type of input diagnostics	Group diagnostics
Sensor supply (V_{SENS})	24 VDC
Low-level signal voltage	4.5 V
Low-level signal voltage	< 4.5 VDC
High-level signal voltage	7...30 VDC
Low-level signal current	< 1.5 mA
High-level signal current	2.1...3.7 mA
Input delay	0.25 or 2.5 ms (configurable)

Digital outputs	
Output type	PNP
Sensor supply (V_{SENS})	24 VDC
Output current per channel	0.5 A
Output voltage	24 VDC
Output delay	3 ms
Load type	resistive, inductive, lamp load
Load resistance, resistive	> 48 Ω
Load resistance, inductive	< 1.2 H
Lamp load	< 3 W
Switching frequency, resistive	< 200 Hz
Switching frequency, inductive	< 2 Hz
Switching frequency, lamp load	< 20 Hz
Short-circuit protection	yes

Technology	
Signal type	RS232
Number of channels	1
Transmission level active (URS1)	-15...-3 VDC
Transmission level inactive (URSO)	3...15 VDC
Common-mode range (UGL)	-7...12 VDC
Transmission signals	RxD, TxD, RTS, CTS
Receive data buffer	128 Byte
Send data buffer	64 Byte
Connection type	full duplex
Cable length	15 m
Parameters	transmission rate, diagnostics, data bits, stop bits, XON-character, XOFF-character, parity, flow control
Electrical isolation	isolation of electronics and field level via optocouplers
Dimensions	
Dimensions	168 x 71 x 32.5 mm
Mounting	2 x 5.4 mm diameter holes, 1.7 Nm torque
Weight	570 ± 20 g
Housing material	Glass-filled nylon, nickel plated brass connectors
Housing color	Black
Material screw	Nickel-plated brass
Material label	Polyester with polycarbonate overlay
Ground label material	Nickel plated brass
Protection class	IP67 IP69K
Ambient temperature	-40...+70 °C
Storage temperature	-40...+85 °C
Relative humidity	15 to 95% (non-condensing)
Vibration test	Acc. to IEC 61131-2
- up to 20 g (at 10 up to 150 Hz)	For mounting on base plate or machinery
Shock test	according to IEC 61131-2
Electromagnetic compatibility	Acc. to IEC 61131-2
Approvals and certificates	CE, cULus

Pinning and wiring diagram

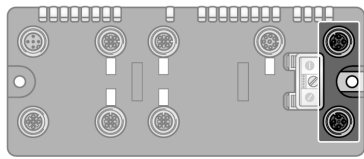

Ethernet

Fieldbus cable (IP67 example): RSSD RSSD 441-2M ID number U-02482 or RSSD-RSSD-441-2M/S2174 ID number 6914218

Pin Assignment (M12, D-code)

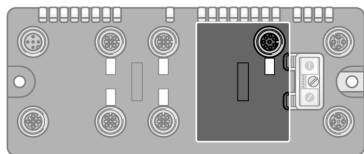
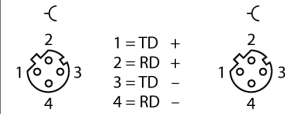

Slot 1: RS232 Interface

Extension cable (example): E-RKC 8T-264-2-RSS 8T/BL/S1500 ident-no. U-89641 or BS8181-0 ident-no. 6901004

Pin Assignment

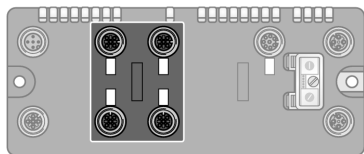
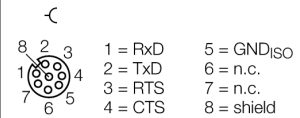

Slot 2: Digital Inputs and Outputs

Extension cable (example): RKC 4.4T-2-RSC 4.4T ident-no. U5264 or RKC4.4T-2-RSC4.4T/TEL ident-no. 6625208

Pin Assignment

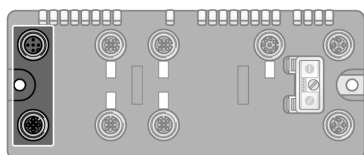
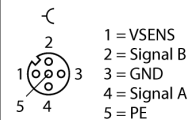

Auxiliary Power

Extension cable (example): RK 4.4T-2-RS 4.4T ident-no. U2445 or RKC4.4T-2-RSC4.4T/TEL ident-no. 6625208

Pin Assignment

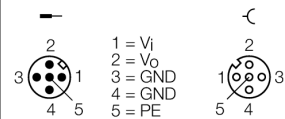

Station LED status

LED	Color	Status	Description
IOs		OFF	No power
	RED	ON	Low power or station error
	RED	FLASHING (1 Hz)	I/O module configuration error
	RED	FLASHING (4 Hz)	No I/O module bus communication
	GREEN	ON	Station ok
	GREEN	FLASHING	Force mode active
BUS		OFF	Power Off
	GREEN	ON	Connected to Master
	GREEN	FLASHING	Ready
	GREEN	FLASHING 3x (1Hz)	ARGEE Running
	RED	ON	Error
	RED	FLASHING	WINK
	YELLOW	ON	DHCP/BOOTP Search
LNK/ACT		OFF	No Link
	GREEN	ON	Link
	GREEN	FLASHING	Traffic
	YELLOW	ON	100 Mbit Linked

I/O LED status slot 1

LED	Color	Status	Description
D1 *		OFF	No diagnostics active
	RED	ON	Station error/ module bus communication failure
	RED	FLASHING (0.5Hz)	Diagnostics active (Slot 1)

* D1 LED also indicates gateway diagnostics

I/O LED status slot 2

LED	Color	Status	Description
D2 *		OFF	No diagnostics active
	RED	ON	Station error/ module bus communication failure
	RED	FLASHING (0.5Hz)	Diagnostics active (Slot 2)
XSG channels 2 ₀ ...2 ₇		OFF	Channel status x = "0" (OFF), no diagnostics active
	GREEN	ON	Channel status x = "1" (ON)
	RED	ON	Short-circuit at output

* D2 LED also indicates gateway diagnostics

Process Data Mapping of Each Protocol

EtherNet/IP™ I/O & Diagnostics Data Mapping

INPUT	BYTE	Bit 7	Bit 6	Bit 5	Bit 4	Bit 3	Bit 2	Bit 1	Bit 0
RS232 1, Status Bytes	0	STAT	TX_CNT_ACK		RX_CNT		RX_BYTE_CNT		
	1	BUF_OVFL	FRAME_ERR	HNSH_ERR	HW_FAILURE	PRM_ERR	-	-	-
RS232 1, User Data	2...7	Data Bytes 0...5							
8XSG	8	DI 2 ₇	DI 2 ₆	DI 2 ₅	DI 2 ₄	DI 2 ₃	DI 2 ₂	DI 2 ₁	DI 2 ₀
	9	-	-	-	-	-	-	-	-
Diagnostics	10	Module number reporting diagnostic data							
	11	Replace Station	-	Diagnostics Active	-	-	-	-	-
Slot 1* (ref. Byte 10)	12	-	-	-	Buffer Overflow	Frame Error	Data Flow Control Error	Hardware Failure	Parameterization Error
	13	-	-	-	-	-	-	-	-
OUTPUT	BYTE	Bit 7	Bit 6	Bit 5	Bit 4	Bit 3	Bit 2	Bit 1	Bit 0
RS232 1, Control Byte	0	STAT_RES	RX_CNT_ACK		TCX_CNT		TX_BYTE_CNT		
	1	-	-	-	-	-	-	RXBUF_FLUSH	TXBUF_FLUSH
RS232 1, User Data	2...7	Data Bytes 0...5							
8XSG	8	DO 2 ₇	DO 2 ₆	DO 2 ₅	DO 2 ₄	DO 2 ₃	DO 2 ₂	DO 2 ₁	DO 2 ₀
	9	-	-	-	-	-	-	-	-

ATTENTION !

1RS232 has additional data format available; contact TURCK technical support for details.

Modbus® TCP Register Mapping

	REG	Bit 15	Bit 14	Bit 13	Bit 12	Bit 11	Bit 10	Bit 9	Bit 8	Bit 7	Bit 6	Bit 5	Bit 4	Bit 3	Bit 2	Bit 1	Bit 0
Inputs (RO)	0x0000	BUF_OVFL	FRM_ERR	HNSH_ERR	HW_ERR	PRM	-	-	-	STAT	TX_CNT_ACK	RX_CNT			RX_BYTE_CNT		
	0x0001 ... 0x0003	Read Data (3 Words)															
	0x0004	-	-	-	-	-	-	-	-	DI 2 ₇	DI 2 ₆	DI 2 ₅	DI 2 ₄	DI 2 ₃	DI 2 ₂	DI 2 ₁	DI 2 ₀
Status (RO)	0x0005	-	FCE	-	-	CFG	COM	VI low	-	VO low	-	-	-	-	-	-	DIA
Diag. (RO)	0x0006	-	-	-	-	-	-	-	-	-	-	-	-	-	-	S2 DIA	S1 DIA
Outputs (RW)	0x0800	-	-	-	-	-	-	RXBUF_FLUSH	TXBUF_FLUSH	STAT_RES	RX_CNT_ACK	TCX_CNT			TX_BYTE_CNT		
	0x0801 ... 0x0804	Write Data (3 Words)															
	0x0805	-	-	-	-	-	-	-	-	DO 2 ₇	DO 2 ₆	DO 2 ₅	DO 2 ₄	DO 2 ₃	DO 2 ₂	DO 2 ₁	DO 2 ₀
I/O Diag. (RO)	0xA000	-	-	-	-	-	-	-	-	OF	FRM	DFC	HW	PRM	-	-	-
	0xA001	SCDO ₂₇	SCDO ₂₆	SCDO ₂₅	SCDO ₂₄	SCDO ₂₃	SCDO ₂₂	SCDO ₂₁	SCDO ₂₀	SCDI ₂₇	SCDI ₂₆	SCDI ₂₅	SCDI ₂₄	SCDI ₂₃	SCDI ₂₂	SCDI ₂₁	SCDI ₂₀

PROFINET® Process Data

Inputs	0	STAT	TX_CNT_ACK		RX_CNT		RX_BYTE_CNT		
	1	BUF_OVFL	FRAME_ERR	HNSH_ERR	HW_FAILURE	PRM_ERR	-	-	-
	2...7	Data Bytes 0...5							
	8	DI 2 ₇	DI 2 ₆	DI 2 ₅	DI 2 ₄	DI 2 ₃	DI 2 ₂	DI 2 ₁	DI 2 ₀
	9	-	-	-	-	-	-	-	-
Outputs	0	STAT_RES	RX_CNT_ACK		TCX_CNT		TX_BYTE_CNT		
	1	-	-	-	-	-	-	RXBUF_FLUSH	TXBUF_FLUSH
	2...7	Data Bytes 0...5							
	8	DO 2 ₇	DO 2 ₆	DO 2 ₅	DO 2 ₄	DO 2 ₃	DO 2 ₂	DO 2 ₁	DO 2 ₀
	9	-	-	-	-	-	-	-	-