

BL compact™ multiprotocol fieldbus station for Industrial Ethernet

4 Digital PNP Outputs

BLCEN-4M12VMH-4DO-2A-P

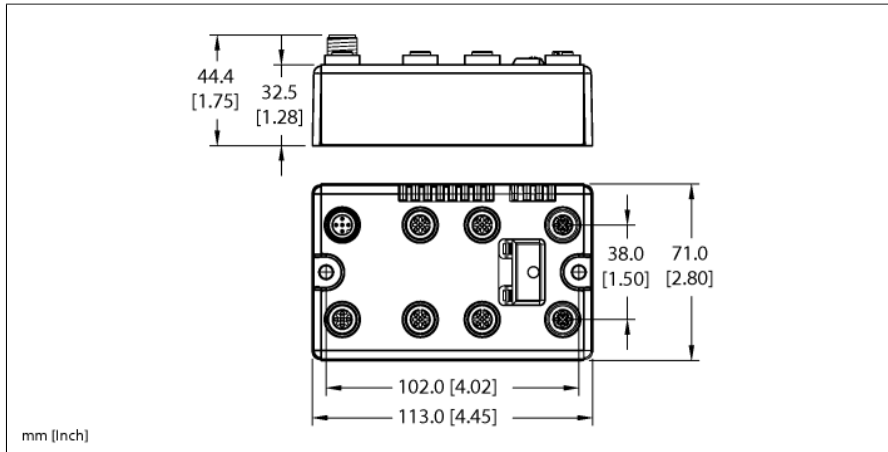

ID	6811487
Nominal system voltage	24 VDC
System power supply	Via auxiliary power
Voltage supply connection	2 x M12, 5-pin
Admissible range Vi	11...30 VDC
Nominal current Vi	125 mA
Max. current Vi	1 A
Admissible range Vo	11...30 VDC
Nominal current Vo	100 mA
Max. current Vo	8 A
Fieldbus transmission rate	10/100 Mbps
Adjustment transmission rate	Automatic detection
Fieldbus address range	1...92 0 (192.168.1.254) 93 (BOOTP) 94 (DHCP) 95 (PGM) 96 (PGM-DHCP) *recommended for PROFINET 97...98 (manufacturer specific)
Fieldbus addressing	2 decimally coded rotary switches
Fieldbus connection technology	2 x M12 4-pole, D-coded
Protocol detection	automatic
Web server	Integrated
Service interface	Ethernet
Vendor ID	48
Product type	12
Product code	11487

- On-machine Compact fieldbus I/O block
- EtherNet/IP™, Modbus® TCP, or PROFINET slave
- Integrated Ethernet Switch
- 10 Mbps / 100 Mbps supported
- Two 4-pole M12, D-coded, connectors for fieldbus connection
- 2 rotary switches for node address
- IP67, IP69K
- All exposed metal is stainless steel
- LEDs indicating status and diagnostics
- Electronics galvanically separated from the field level via optocouplers
- 4 digital PNP outputs, 24 VDC
- Max. 2A per output (8A total)
- Two 5-pole M12 male connectors for auxiliary power connection

Modbus TCP	
Addressing	Static IP, BOOTP, DHCP
Supported function codes	FC1, FC2, FC3, FC4, FC5, FC6, FC15, FC16, FC23
Number of TCP connections	6
Input Data Size	max. 2 register
Input register start address	0 (0x0000 hex)
Output Data Size	max. 1 register
Output register start address	2048 (0x0800 hex)

Ethernet/IP	
Addressing	acc. to EtherNet/IP specification
Device Level Ring (DLR)	supported
Class 1 connections (CIP)	6
Input Assembly Instance	103
Input Data Size	2 INT
Output Assembly Instance	104
Output Data Size	1 INT
Configuration Assembly Instance	106
Configuration Size	0
Comm Format	Data - INT

PROFINET	
Addressing	DCP
Conformance class	B (RT)
MinCycleTime	1 ms
Diagnostics	acc. to PROFINET alarm handling
Topology detection	supported
Automatic addressing	supported
Media Redundancy Protocol (MRP)	supported
Output Data Size	max. 2 BYTE

Digital outputs	
Output type	PNP
Type of output diagnostics	Channel diagnostics
Sensor supply (V_{SENSE})	24 VDC
Output current per channel	2 A
Output voltage	24 VDC from supply voltage
Output delay	3 ms
Load type	resistive, inductive, lamp load
Load resistance, resistive	> 12 Ω
Load resistance, inductive	< 1.2 H
Lamp load	< 10 W
Switching frequency, resistive	< 200 Hz
Switching frequency, inductive	< 2 Hz
Switching frequency, lamp load	< 20 Hz
Short-circuit protection	yes

Dimensions	113 x 71 x 32.5 mm
Mounting	2 × 5.4 mm diameter holes, 1.7 Nm torque
Weight	390 ± 20 g
Housing material	Glass-filled nylon, 316L stainless steel connectors
Housing color	Black
Material screw	303 stainless steel
Material label	Polyester with polycarbonate overlay
Ground label material	304 Stainless Steel
Protection class	IP67 IP69K
Ambient temperature	-40...+70 °C
Storage temperature	-40...+85 °C
Relative humidity	15 to 95% (non-condensing)
Vibration test	Acc. to IEC 61131-2
- up to 20 g (at 10 up to 150 Hz)	For mounting on base plate or machinery
Shock test	according to IEC 61131-2
Electromagnetic compatibility	Acc. to IEC 61131-2
MTTF	170 years
MTTF note	acc. to SN 29500 (Ed. 99) 20 °C
Approvals and certificates	CE, cULus

Pinning and wiring diagram

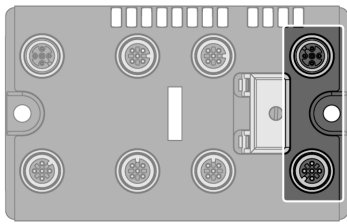

Ethernet

Fieldbus cable (IP67 example): RSSD RSSD 441-2M ID number U-02482 or RSSD-RSSD-441-2M/S2174 ID number 6914218

Pin Assignment (M12, D-code)

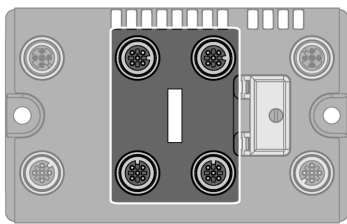
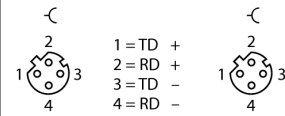

Digital Outputs

Extension cable (example): RK 4T-2-RS 4T ident-no. U2151-3 or RKC4T-2-RSC4T/TEL ident-no. 6625204

Pin Assignment

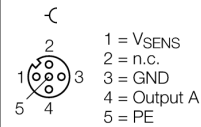

Wiring Diagram

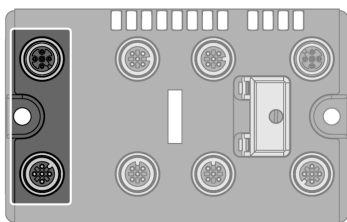
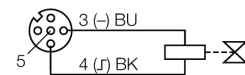

Auxiliary Power

Extension cable (example): RKC 4.4T-2-RSC 4.4T ident-no. U5264 or RKC4.4T-2-RSC4.4T/TEL ident-no. 6625208

Pin Assignment

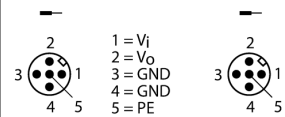

Station LED status

LED	Color	Status	Description
IOs		OFF	No power
	RED	ON	Low power or station error
	RED	FLASHING (1 Hz)	I/O module configuration error
	RED	FLASHING (4 Hz)	No I/O module bus communication
	GREEN	ON	Station ok
	GREEN	FLASHING	Force mode active
BUS		OFF	Power Off
	GREEN	ON	Connected to Master
	GREEN	FLASHING	Ready
	GREEN	FLASHING 3x (1Hz)	ARGE Running
	RED	ON	Error
	RED	FLASHING	WINK
	YELLOW	ON	DHCP/BOOTP Search
LNK/ACT		OFF	No Link
	GREEN	ON	Link
	GREEN	FLASHING	Traffic
	YELLOW	ON	100 Mbit Linked

I/O LED status

LED	Color	Status	Description
D *		OFF	No diagnostics active
	RED	ON	Station error/ module bus communication failure
	RED	FLASHING (0.5Hz)	Diagnostics active
DO channels 0...3		OFF	Status of channel x = „0“ (OFF), no diagnostics active
	GREEN	ON	Status of channel x = „1“ (ON)
	RED	ON	Short circuit / overload on channel x

* D LED also indicates gateway diagnostics

Process Data Mapping of Each Protocol

EtherNet/IP™ I/O & Diagnostics Data Mapping

INPUT	BYTE	Bit 7	Bit 6	Bit 5	Bit 4	Bit 3	Bit 2	Bit 1	Bit 0
Diagnostics	0	Module number reporting diagnostic data							
	1	Replace Station	-	Diagnostics Active	-	-	-	-	-
Slot 1 (ref. Byte 0)	2	-	-	-	-	Over Current DO 1 ₃	Over Current DO 1 ₂	Over Current DO 1 ₁	Over Current DO 1 ₀
	3	-	-	-	-	-	-	-	-
OUTPUT	BYTE	Bit 7	Bit 6	Bit 5	Bit 4	Bit 3	Bit 2	Bit 1	Bit 0
	0	-	-	-	-	DO 1 ₃	DO 1 ₂	DO 1 ₁	DO 1 ₀
	1	-	-	-	-	-	-	-	-

Legend:

CFG	Configuration Error	FCE	Force Mode Active
COM	Communication Failure	SC	Short Circuit / Overcurrent
DIA	Diagnostics Active	VI	VI Voltage
DO	Digital Output	VO	VO Voltage

Modbus® TCP Register Mapping

	REG	Bit 15	Bit 14	Bit 13	Bit 12	Bit 11	Bit 10	Bit 9	Bit 8	Bit 7	Bit 6	Bit 5	Bit 4	Bit 3	Bit 2	Bit 1	Bit 0
Status (RO)	0x0000	-	FCE	-	-	CFG	COM	VI low	-	VO low	-	-	-	-	-	-	DIA
Diag. (RO)	0x0000	-	-	-	-	-	-	-	-	-	-	-	-	-	-	-	S1 DIA
Outputs (RW)	0x0800	-	-	-	-	-	-	-	-	-	-	-	-	DO 1 ₃	DO 1 ₂	DO 1 ₁	DO 1 ₀
I/O Diag. (RO)	0xA000	-	-	-	-	-	-	-	-	-	-	-	-	SCDO 1 ₃	SCDO 1 ₂	SCDO 1 ₁	SCDO 1 ₀

PROFINET® Process Data

	BYTE	Bit 7	Bit 6	Bit 5	Bit 4	Bit 3	Bit 2	Bit 1	Bit 0
Outputs	0	-	-	-	-	DO 1 ₃	DO 1 ₂	DO 1 ₁	DO 1 ₀
	1	-	-	-	-	-	-	-	-