

# BL compact™ multiprotocol fieldbus station for Industrial Ethernet

## 8 Configurable Digital PNP Channels

### BLCEN-4M12MT-8XSG-P

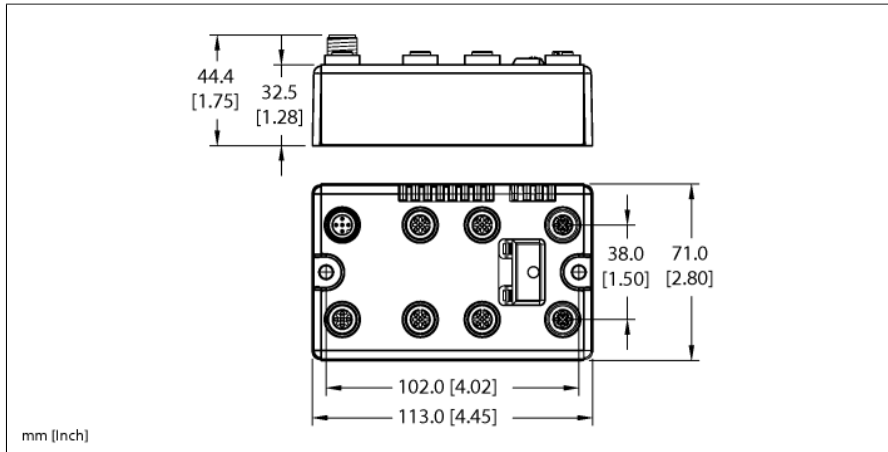

ID	6811452
Nominal system voltage	24 VDC
System power supply	Via auxiliary power
Voltage supply connection	2 x M12, 5-pin
Admissible range $V_i$	18...30 VDC
Nominal current $V_i$	225 mA
Max. current $V_i$	1 A
Admissible range $V_o$	18...30 VDC
Nominal current $V_o$	100 mA
Max. current $V_o$	4 A
Electrical isolation	The 8XSG I/O cards have a common reference potential for operating and load voltage due to their freely selectable digital channels. Subsequently, all voltage sources ( $V_i$ / $V_o$ / $V_+$ ) present on this device must be concurrently connected to suitable power supplies.
Fieldbus transmission rate	10/100 Mbps
Adjustment transmission rate	Automatic detection
Fieldbus address range	1...92 0 (192.168.1.254) 93 (BOOTP) 94 (DHCP) 95 (PGM) 96 (PGM-DHCP) *recommended for PROFINET 97...98 (manufacturer specific)
Fieldbus addressing	2 decimally coded rotary switches
Fieldbus connection technology	2 x M12 4-pole, D-coded
Protocol detection	automatic
Web server	Integrated
Service interface	Ethernet
Vendor ID	48
Product type	12
Product code	11452

- On-machine Compact fieldbus I/O block
- EtherNet/IP™, Modbus® TCP, or PROFINET slave
- Integrated Ethernet Switch
- 10 Mbps / 100 Mbps supported
- Two 4-pole M12, D-coded, connectors for fieldbus connection
- 2 rotary switches for node address
- IP67, IP69K
- M12 I/O connectors
- LEDs indicating status and diagnostics
- Electronics galvanically separated from the field level via optocouplers
- 8 Configurable digital PNP channels, 24 VDC
- Max. 0.5A per channel
- Selection of filtering times (Input delay)
- Invertible inputs

Modbus TCP	
Addressing	Static IP, BOOTP, DHCP
Supported function codes	FC1, FC2, FC3, FC4, FC5, FC6, FC15, FC16, FC23
Number of TCP connections	6
Input Data Size	max. 3 register
Input register start address	0 (0x0000 hex)
Output Data Size	max. 1 register
Output register start address	2048 (0x0800 hex)

Ethernet/IP	
Addressing	acc. to EtherNet/IP specification
Device Level Ring (DLR)	supported
Class 1 connections (CIP)	6
Input Assembly Instance	103
Input Data Size	3 INT
Output Assembly Instance	104
Output Data Size	1 INT
Configuration Assembly Instance	106
Configuration Size	0
Comm Format	Data - INT

PROFINET	
Addressing	DCP
Conformance class	B (RT)
MinCycleTime	1 ms
Diagnostics	acc. to PROFINET alarm handling
Topology detection	supported
Automatic addressing	supported
Media Redundancy Protocol (MRP)	supported
Input Data Size	max. 2 BYTE
Output Data Size	max. 2 BYTE

Digital inputs	
Input type	PNP
Type of input diagnostics	Group diagnostics
Sensor supply ( $V_{\text{SENS}}$ )	24 VDC
Low-level signal voltage	< 4.5 VDC
High level signal voltage	7 ... 30 VDC
Low level signal current	< 1.5 mA
High level signal current	2.1 ... 3.7 mA
Input delay	0.25 ms or 2.5 ms (configurable)

Digital outputs	
Output type	PNP
Sensor supply ( $V_{\text{SENS}}$ )	24 VDC
Output current per channel	0.5 A
Output voltage	24 VDC from supply voltage
Output delay	3 ms
Load type	resistive, inductive, lamp load
Load resistance, resistive	> 48 $\Omega$
Load resistance, inductive	< 1.2 H
Lamp load	< 3 W
Switching frequency, resistive	< 200 Hz
Switching frequency, inductive	< 2 Hz
Switching frequency, lamp load	< 20 Hz
Short-circuit protection	yes

Dimensions	113 x 71 x 32.5 mm
Mounting	2 × 5.4 mm diameter holes, 1.7 Nm torque
Weight	390 ± 20 g
Housing material	Glass-filled nylon, nickel plated brass connectors
Housing color	Black
Material screw	Nickel-plated brass
Material label	Polyester with polycarbonate overlay
Ground label material	Nickel plated brass
Protection class	IP67 IP69K
Ambient temperature	-40...+70 °C
Storage temperature	-40...+85 °C
Relative humidity	15 to 95% (non-condensing)
Vibration test	Acc. to IEC 61131-2
- up to 20 g (at 10 up to 150 Hz)	For mounting on base plate or machinery
Shock test	according to IEC 61131-2
Electromagnetic compatibility	Acc. to IEC 61131-2
MTTF	134 years
MTTF note	acc. to SN 29500 (Ed. 99) 20 °C
Approvals and certificates	CE, cULus, Class I Div.2

## Pinning and wiring diagram

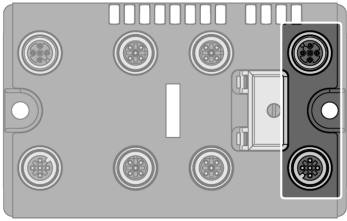
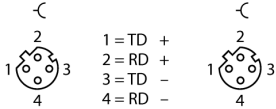
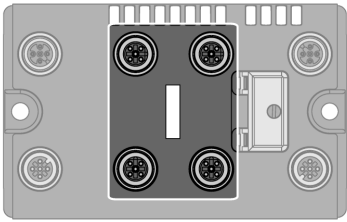
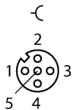
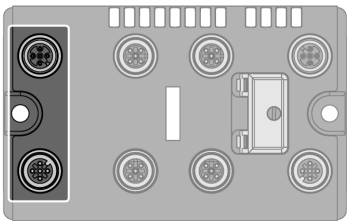
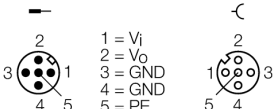
	<p><b>Ethernet</b>            Fieldbus cable (IP67 example): RSSD RSSD 441-2M ID number U-02482 or RSSD-RSSD-441-2M/S2174 ID number 6914218</p>	<p>Pin assignment (M12, D-coded)</p>  <p>1 = TD +            2 = RD +            3 = TD -            4 = RD -</p>
	<p><b>Digital Inputs and Outputs</b>            Extension cable (example): RK 4.4T-2-RS 4.4T ident-no. U2445 or RKC4.4T-2-RSC4.4T/TEL ident-no. 6625208</p>	<p>Pin Assignment</p>  <p>1 = VSENS            2 = Signal B            3 = GND            4 = Signal A            5 = PE</p>
	<p><b>Auxiliary Power</b>            Extension cable (example): RKC 4.4T-2-RSC 4.4T ident-no. U5264 or RKC4.4T-2-RSC4.4T/TEL ident-no. 6625208</p>	<p>Pin Assignment</p>  <p>1 = Vi            2 = Vo            3 = GND            4 = GND            5 = PE</p>

**Station LED status**

LED	Color	Status	Description
IOs		OFF	No power
	RED	ON	Low power or station error
	RED	FLASHING (1 Hz)	I/O module configuration error
	RED	FLASHING (4 Hz)	No I/O module bus communication
	GREEN	ON	Station ok
	GREEN	FLASHING	Force mode active
BUS		OFF	Power Off
	GREEN	ON	Connected to Master
	GREEN	FLASHING	Ready
	GREEN	FLASHING 3x (1Hz)	ARGEE Running
	RED	ON	Error
	RED	FLASHING	WINK
	YELLOW	ON	DHCP/BOOTP Search
LNK/ACT		OFF	No Link
	GREEN	ON	Link
	GREEN	FLASHING	Traffic
	YELLOW	ON	100 Mbit Linked

**I/O LED status**

LED	Color	Status	Description
D *		OFF	No diagnostics active
	RED	ON	Station error/ module bus communication failure
	RED	FLASHING (0.5Hz)	Diagnostics active
XSG channels 0...7		OFF	Channel status x = "0" (OFF), no diagnostics active
	GREEN	ON	Channel status x = "1" (ON)
	RED	ON	Short-circuit at output

\* D LED also indicates gateway diagnostics

## Process Data Mapping of Each Protocol

### EtherNet/IP™ I/O & Diagnostics Data Mapping

INPUT	BYTE	Bit 7	Bit 6	Bit 5	Bit 4	Bit 3	Bit 2	Bit 1	Bit 0
	0	DI 1 <sub>7</sub>	DI 1 <sub>6</sub>	DI 1 <sub>5</sub>	DI 1 <sub>4</sub>	DI 1 <sub>3</sub>	DI 1 <sub>2</sub>	DI 1 <sub>1</sub>	DI 1 <sub>0</sub>
	1	-	-	-	-	-	-	-	-
	2	-	-	-	-	-	-	-	-
	3	-	-	-	-	-	-	-	-
	4	-	-	-	-	-	-	-	-
	5	-	-	-	-	-	-	-	-
OUTPUT	BYTE	Bit 7	Bit 6	Bit 5	Bit 4	Bit 3	Bit 2	Bit 1	Bit 0
	0	DO 1 <sub>7</sub>	DO 1 <sub>6</sub>	DO 1 <sub>5</sub>	DO 1 <sub>4</sub>	DO 1 <sub>3</sub>	DO 1 <sub>2</sub>	DO 1 <sub>1</sub>	DO 1 <sub>0</sub>
	1	-	-	-	-	-	-	-	-

Legend:

CFG	Configuration Error	FCE	Force Mode Active
COM	Communication Error	SC	Short Circuit / Overcurrent
DIA	Diagnostics Active	VI	VI Voltage
DI	Digital Input	VO	VO Voltage
DO	Digital Output		

### Modbus® TCP Register Mapping

	REG	Bit 15	Bit 14	Bit 13	Bit 12	Bit 11	Bit 10	Bit 9	Bit 8	Bit 7	Bit 6	Bit 5	Bit 4	Bit 3	Bit 2	Bit 1	Bit 0
Inputs (RO)	0x0000	-	-	-	-	-	-	-	-	DI 1 <sub>7</sub>	DI 1 <sub>6</sub>	DI 1 <sub>5</sub>	DI 1 <sub>4</sub>	DI 1 <sub>3</sub>	DI 1 <sub>2</sub>	DI 1 <sub>1</sub>	DI 1 <sub>0</sub>
Status (RO)	0x0001	-	FCE	-	-	CFG	COM	VI low	-	VO low	-	-	-	-	-	-	DIA
Diag. (RO)	0x0002	-	-	-	-	-	-	-	-	-	-	-	-	-	-	-	S1 DIA
Outputs (RW)	0x0800	-	-	-	-	-	-	-	-	DO 1 <sub>7</sub>	DO 1 <sub>6</sub>	DO 1 <sub>5</sub>	DO 1 <sub>4</sub>	DO 1 <sub>3</sub>	DO 1 <sub>2</sub>	DO 1 <sub>1</sub>	DO 1 <sub>0</sub>
I/O Diag. (RO)	0xA000	SCDO 1 <sub>7</sub>	SCDO 1 <sub>6</sub>	SCDO 1 <sub>5</sub>	SCDO 1 <sub>4</sub>	SCDO 1 <sub>3</sub>	SCDO 1 <sub>2</sub>	SCDO 1 <sub>1</sub>	SCDO 1 <sub>0</sub>	SCDI 1 <sub>7</sub>	SCDI 1 <sub>6</sub>	SCDI 1 <sub>5</sub>	SCDI 1 <sub>4</sub>	SCDI 1 <sub>3</sub>	SCDI 1 <sub>2</sub>	SCDI 1 <sub>1</sub>	SCDI 1 <sub>0</sub>

### PROFINET® Process Data

	BYTE	Bit 7	Bit 6	Bit 5	Bit 4	Bit 3	Bit 2	Bit 1	Bit 0
Inputs	0	DI 1 <sub>7</sub>	DI 1 <sub>6</sub>	DI 1 <sub>5</sub>	DI 1 <sub>4</sub>	DI 1 <sub>3</sub>	DI 1 <sub>2</sub>	DI 1 <sub>1</sub>	DI 1 <sub>0</sub>
	1	-	-	-	-	-	-	-	-
Outputs	0	DO 1 <sub>7</sub>	DO 1 <sub>6</sub>	DO 1 <sub>5</sub>	DO 1 <sub>4</sub>	DO 1 <sub>3</sub>	DO 1 <sub>2</sub>	DO 1 <sub>1</sub>	DO 1 <sub>0</sub>
	1	-	-	-	-	-	-	-	-

## Accessories

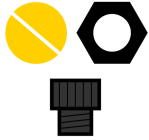
Type code	Ident-No.		Dimension drawing
LOCK-EURO-C	A0885	Locking guard for straight eurofast™ C-body connectors (RKC, RKCV, RSC, RSCV) in a Class I, Division 2 installations	
LOCK-EURO-C (10/BAG)	A0886	Locking guard for straight eurofast™ C-body connectors (RKC, RKCV, RSC, RSCV) in a Class I, Division 2 installations	