

BL compact™ multiprotocol fieldbus station for Industrial Ethernet

2 Analoga Inputs for Thermocouple Elements

BLCEN-2M12MT-2AI-TC

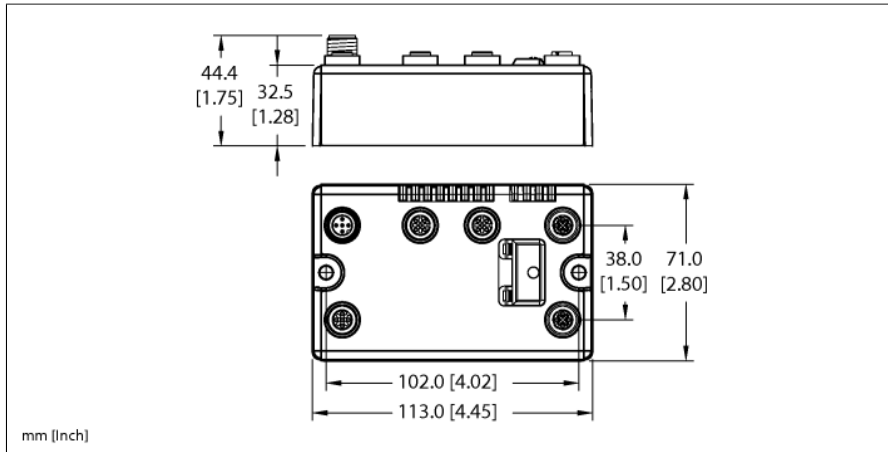

ID	6811465
Nominal system voltage	24 VDC
System power supply	Via auxiliary power
Voltage supply connection	2 x M12, 5-pin
Admissible range Vi	11...30 VDC
Nominal current Vi	155 mA
Max. current Vi	1 A
Fieldbus transmission rate	10/100 Mbps
Adjustment transmission rate	Automatic detection
Fieldbus address range	1...92 0 (192.168.1.254) 93 (BOOTP) 94 (DHCP) 95 (PGM) 96 (PGM-DHCP) *recommended for PROFINET 97...98 (manufacturer specific)
Fieldbus addressing	2 decimally coded rotary switches
Fieldbus connection technology	2 x M12 4-pole, D-coded
Protocol detection	automatic
Web server	Integrated
Service interface	Ethernet
Vendor ID	48
Product type	12
Product code	11465
Modbus TCP	
Addressing	Static IP, BOOTP, DHCP
Supported function codes	FC1, FC2, FC3, FC4, FC5, FC6, FC15, FC16, FC23
Number of TCP connections	6
Input Data Size	max. 4 register
Input register start address	0 (0x0000 hex)

- On-machine Compact fieldbus I/O block
- EtherNet/IP™, Modbus® TCP, or PROFINET slave
- Integrated Ethernet Switch
- 10 Mbps / 100 Mbps supported
- Two 4-pole M12, D-coded, connectors for fieldbus connection
- 2 rotary switches for node address
- IP67, IP69K
- M12 I/O connectors
- LEDs indicating status and diagnostics
- Electronics galvanically separated from the field level via optocouplers
- 2 analog inputs for Thermo Couples
- Types B, E, J, K, N, R, S or T (selectable per channel)
- Cold-junction compensation via a Pt1000 in special connector

Ethernet/IP	
Addressing	acc. to EtherNet/IP specification
Device Level Ring (DLR)	supported
Class 1 connections (CIP)	6
Input Assembly Instance	103
Input Data Size	4 INT
Output Assembly Instance	104
Output Data Size	1 INT
Configuration Assembly Instance	106
Configuration Size	0
Comm Format	Data - INT

PROFINET	
Addressing	DCP
Conformance class	B (RT)
MinCycleTime	1 ms
Diagnostics	acc. to PROFINET alarm handling
Topology detection	supported
Automatic addressing	supported
Media Redundancy Protocol (MRP)	supported
Input Data Size	max. 4 BYTE

Analog inputs	
Operating modes	Types B, E, J, K, N, R, S, T
Type of input diagnostics	Channel diagnostics
Sensor supply	24 VDC, 1 amp max.
Voltage resolution	± 50 mV: < 2 µV ± 100 mV: < 4 µV ± 500 mV: < 20 µV ± 1000 mV: < 50 µV
Basic fault limit at 23 °C	< 0.2 %
Repeatability	< 0.05 %
Temperature coefficient	< 300 ppm / °C of full scale
Resolution	16 Bit
Measurement display	16 bit signed integer 12 bit full range left-justified

Dimensions	113 x 71 x 32.5 mm
Mounting	2 × 5.4 mm diameter holes, 1.7 Nm torque
Weight	360 ± 20 g
Housing material	Glass-filled nylon, nickel plated brass connectors
Housing color	Black
Material screw	Nickel-plated brass
Material label	Polyester with polycarbonate overlay
Ground label material	Nickel plated brass
Protection class	IP67 IP69K
Ambient temperature	-40...+70 °C
Storage temperature	-40...+85 °C
Relative humidity	15 to 95% (non-condensing)
Vibration test	Acc. to IEC 61131-2
- up to 20 g (at 10 up to 150 Hz)	For mounting on base plate or machinery
Shock test	according to IEC 61131-2
Electromagnetic compatibility	Acc. to IEC 61131-2
Approvals and certificates	CE, cULus

Pinning and wiring diagram

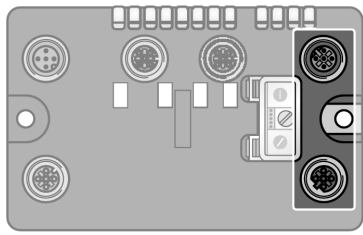

Ethernet

Fieldbus cable (IP67 example): RSSD RSSD 441-2M ID number U-02482 or RSSD-RSSD-441-2M/S2174 ID number 6914218

Pin Assignment (M12, D-code)

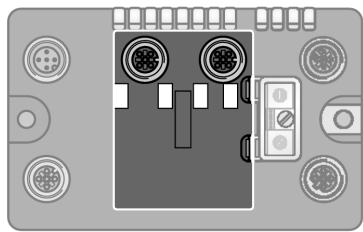
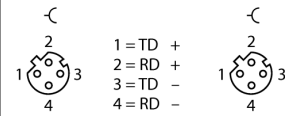

Thermocouple Inputs

TC compensating connector BL67-WAS5-THERMO ident-no. 6827197

Pin Assignment

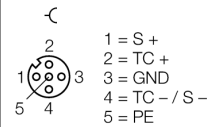

Wiring Diagram

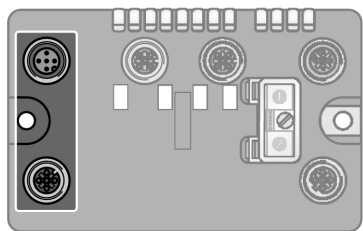
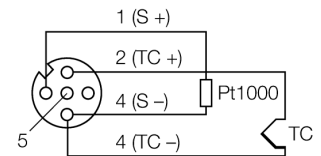

Auxiliary Power

Extension cable (example): RKC 4.4T-2-RSC 4.4T ident-no. U5264 or RKC4.4T-2-RSC4.4T/TEL ident-no. 6625208

Pin Assignment

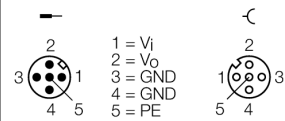

Station LED status

LED	Color	Status	Description
IOs		OFF	No power
	RED	ON	Low power or station error
	RED	FLASHING (1 Hz)	I/O module configuration error
	RED	FLASHING (4 Hz)	No I/O module bus communication
	GREEN	ON	Station ok
	GREEN	FLASHING	Force mode active
BUS		OFF	Power Off
	GREEN	ON	Connected to Master
	GREEN	FLASHING	Ready
	GREEN	FLASHING 3x (1Hz)	ARGE Running
	RED	ON	Error
	RED	FLASHING	WINK
	YELLOW	ON	DHCP/BOOTP Search
LNK/ACT		OFF	No Link
	GREEN	ON	Link
	GREEN	FLASHING	Traffic
	YELLOW	ON	100 Mbit Linked

I/O LED status

LED	Color	Status	Description
D *		OFF	No diagnostics active
	RED	ON	Station error/ module bus communication failure
	RED	FLASHING (0.5Hz)	Diagnostics active
AI channel 0 / 1			Not connected

* D LED also indicates gateway diagnostics

Process Data Mapping of Each Protocol

EtherNet/IP™ I/O & Diagnostics Data Mapping

INPUT	BYTE	Bit 7	Bit 6	Bit 5	Bit 4	Bit 3	Bit 2	Bit 1	Bit 0
AI 1 ₀	0	AI 1 ₀ LSB							
	1	AI 1 ₀ MSB							
AI 1 ₁	2	AI 1 ₁ LSB							
	3	AI 1 ₁ MSB							
Diagnostics	4	Module number reporting diagnostic data							
	5	Replace Station	-	Diagnostics Active	-	-	-	-	-
Slot 1 (ref. Byte 4)	6	-	-	-	-	-	Cold Junction AI 1 ₀	Open Circuit AI 1 ₀	Range Error AI 1 ₀
	7	-	-	-	-	-	Cold Junction AI 1 ₁	Open Circuit AI 1 ₁	Range Error AI 1 ₁

Legend:

AI	Analog Input	MR	Measurement Value Range Error
CFG	Configuration Error	OC	Open Circuit
COM	Communication Failure	S1	Slot 1
DIA	Diagnostics Active	VI low	VI Voltage
FCE	Force Mode Active	VO low	VO Voltage
CJ	Cold Junction Error		

Modbus® TCP Register Mapping

	REG	Bit 15	Bit 14	Bit 13	Bit 12	Bit 11	Bit 10	Bit 9	Bit 8	Bit 7	Bit 6	Bit 5	Bit 4	Bit 3	Bit 2	Bit 1	Bit 0	
Inputs (RO)	0x0000	AI 1 ₀																
	0x0001	AI 1 ₁																
Status (RO)	0x0002	-	FCE	-	-	CFG	COM	VI low	-	VO low	-	-	-	-	-	-	DIA	
Diag. (RO)	0x0003	-	-	-	-	-	-	-	-	-	-	-	-	-	-	-	S1 DIA	
I/O Diag. (RO)	0xA000	-	-	-	-	-	CJAI 1 ₁	OCAI 1 ₁	MRAI 1 ₁	-	-	-	-	-	-	CJAI 1 ₀	OCAI 1 ₀	MRAI 1 ₀

PROFINET® Process Data

	BYTE	Bit 7	Bit 6	Bit 5	Bit 4	Bit 3	Bit 2	Bit 1	Bit 0
Inputs	0	AI 1 ₀ LSB							
	1	AI 1 ₀ MSB							
	2	AI 1 ₁ LSB							
	3	AI 1 ₁ MSB							