

BL compact™ multiprotocol fieldbus station for Industrial Ethernet

Digital Counter/Encoder Interface

BLCEN-1M12MT-1CNT-ENC

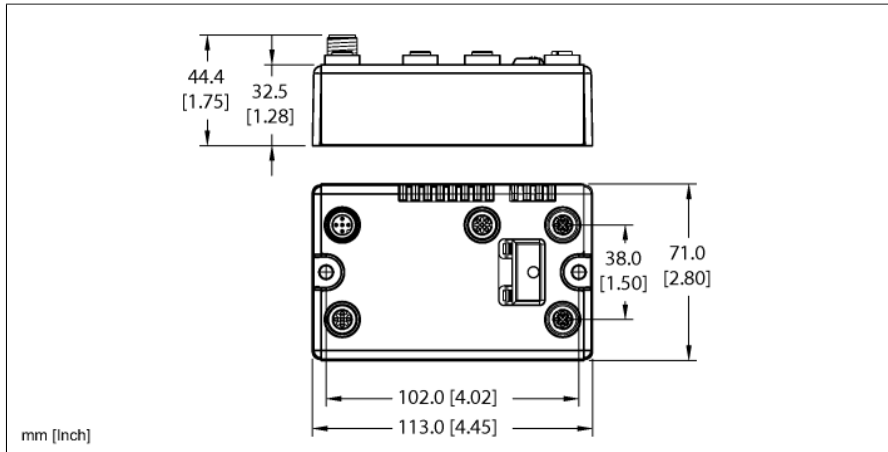

ID	6811479
Nominal system voltage	24 VDC
System power supply	Via auxiliary power
Voltage supply connection	2 x M12, 5-pin
Admissible range Vi	18...30 VDC
Nominal current Vi	225 mA
Max. current Vi	1 A
Admissible range Vo	18...30 VDC
Max. current Vo	4 A
Fieldbus transmission rate	10/100 Mbps
Adjustment transmission rate	Automatic detection
Fieldbus address range	1...92 0 (192.168.1.254) 93 (BOOTP) 94 (DHCP) 95 (PGM) 96 (PGM-DHCP) *recommended for PROFINET 97...98 (manufacturer specific)
Fieldbus addressing	2 decimally coded rotary switches
Fieldbus connection technology	2 x M12 4-pole, D-coded
Protocol detection	automatic
Web server	Integrated
Service interface	Ethernet
Vendor ID	48
Product type	12
Product code	11479

- On-machine Compact fieldbus I/O block
- EtherNet/IP™, Modbus® TCP, or PROFINET slave
- Integrated Ethernet Switch
- 10 Mbps / 100 Mbps supported
- Two 4-pole M12, D-coded, connectors for fieldbus connection
- 2 rotary switches for node address
- IP67, IP69K
- M12 I/O connectors
- LEDs indicating status and diagnostics
- Electronics galvanically separated from the field level via optocouplers
- Detection of standard counting signals
- 5 VDC differential
- 5...24 VDC single ended
- 1 digital PNP input, 24 VDC
- 1 digital PNP output, 24 VDC, 0.5A

Modbus TCP	
Addressing	Static IP, BOOTP, DHCP
Supported function codes	FC1, FC2, FC3, FC4, FC5, FC6, FC15, FC16, FC23
Number of TCP connections	6
Input Data Size	max. 8 register
Input register start address	0 (0x0000 hex)
Output Data Size	max. 4 register
Output register start address	2048 (0x0800 hex)

Ethernet/IP	
Addressing	acc. to EtherNet/IP specification
Device Level Ring (DLR)	supported
Class 1 connections (CIP)	6
Input Assembly Instance	103
Input Data Size	8 INT
Output Assembly Instance	104
Output Data Size	4 INT
Configuration Assembly Instance	106
Configuration Size	0
Comm Format	Data - INT

PROFINET	
Addressing	DCP
Conformance class	B (RT)
MinCycleTime	1 ms
Diagnostics	acc. to PROFINET alarm handling
Topology detection	supported
Automatic addressing	supported
Media Redundancy Protocol (MRP)	supported
Input Data Size	max. 12 BYTE
Output Data Size	max. 8 BYTE

Technology	
Signal type	Counter / Encoder
Number of channels	1
Input type	PNP
Output type	PNP
Output current per channel	0.5 A
Output delay	0.2 ms
Load type	resistive
Short-circuit protection	yes
Sensor supply	24 VDC
Transmission signals	A, B, Z
Frequency measurement	up to 250 kHz
Speed measurement	factor parameterizable
Period duration measurement	400 ns to 858.9 s
Upper count limit	0xFFFFFFFF
Lower count limit	0x80000000
Cable length	30 m
Electrical isolation	isolation of electronics and field level via optocouplers

Dimensions	113 x 71 x 32.5 mm
Mounting	2 × 5.4 mm diameter holes, 1.7 Nm torque
Weight	330 ± 20 g
Housing material	Glass-filled nylon, nickel plated brass connectors
Housing color	Black
Material screw	Nickel-plated brass
Material label	Polyester with polycarbonate overlay
Ground label material	Nickel plated brass
Protection class	IP67 IP69K
Ambient temperature	-40...+70 °C
Storage temperature	-40...+85 °C
Relative humidity	15 to 95% (non-condensing)
Vibration test	Acc. to IEC 61131-2
- up to 20 g (at 10 up to 150 Hz)	For mounting on base plate or machinery
Shock test	according to IEC 61131-2
Electromagnetic compatibility	Acc. to IEC 61131-2
MTTF	120 years
MTTF note	acc. to SN 29500 (Ed. 99) 20 °C
Approvals and certificates	CE, cULus

Pinning and wiring diagram

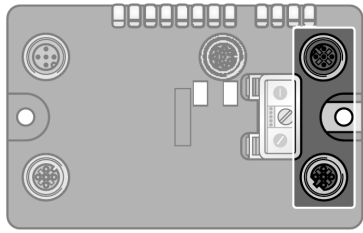

Ethernet

Fieldbus cable (IP67 example): RSSD RSSD 441-2M ID number U-02482 or RSSD-RSSD-441-2M/S2174 ID number 6914218

Pin Assignment (M12, D-code)

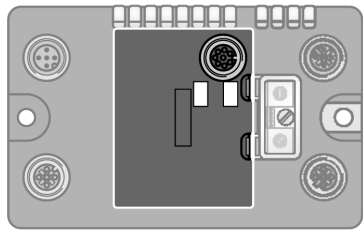
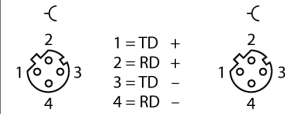

Digital Counter/Encoder Interface

Extension cable (example): E-RKC 8T-264-2-RSS 8T/BL/S1500 ident-no. U-89641 or BS8181-0 ident-no. 6901004

Pin Assignment

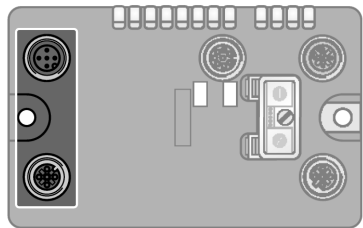
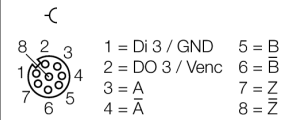

Auxiliary Power

Extension cable (example): RKC 4.4T-2-RSC 4.4T ident-no. U5264 or RKC4.4T-2-RSC4.4T/TEL ident-no. 6625208

Pin Assignment

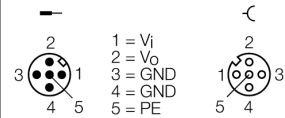

Station LED status

LED	Color	Status	Description
IOs		OFF	No power
	RED	ON	Low power or station error
	RED	FLASHING (1 Hz)	I/O module configuration error
	RED	FLASHING (4 Hz)	No I/O module bus communication
	GREEN	ON	Station ok
	GREEN	FLASHING	Force mode active
BUS		OFF	Power Off
	GREEN	ON	Connected to Master
	GREEN	FLASHING	Ready
	RED	ON	Error
	RED	FLASHING	WINK
	YELLOW	ON	DHCP/BOOTP Search
LNK/ACT		OFF	No Link
	GREEN	ON	Link
	GREEN	FLASHING	Traffic
	YELLOW	ON	100 Mbit Linked

I/O LED status

LED	Color	Status	Description
D *		OFF	No diagnostics active
	RED	ON	Station error/ module bus communication failure
	RED	FLASHING (0.5Hz)	Diagnostics active
A/Z		OFF	Inputs A and Z inactive
	GREEN	ON	Input A active
	RED	ON	Input Z active
	RED & GREEN	ON	Inputs A and Z active
B		OFF	Input B inactive
	GREEN	ON	Input B active resp. direction input indicates "count down"
DO 3		OFF	Output status x = 0 (OFF)
	GREEN	ON	Output status x = 1 (ON)
	RED	ON	Overload at output x
DI 3		OFF	Input status x = 0 (OFF)
	GREEN	ON	Input status x = 1 (ON)

* D LED also indicates gateway diagnostics

Process Data Mapping of Each Protocol

EtherNet/IP™ I/O & Diagnostics Data Mapping

INPUT	BYTE	Bit 7	Bit 6	Bit 5	Bit 4	Bit 3	Bit 2	Bit 1	Bit 0
Status Bytes	0	-	A	B	Z	DI3	DI2	DI1	DI0
	1	ERR_PARA	SYNC_AKN	-	-	-	-	-	Count Direction
	2	REG_WR_ACCEPT	REG_WR_AKN	-	-	-	STS_ZC	STS_OFLW	STS_UFLW
Communication	3	REG_RD_ABORT			REG_ACT_RD_ADR				
User Data	4	REG_RD_DATA, Byte 0							
	5	REG_RD_DATA, Byte 1							
	6	REG_RD_DATA, Byte 2							
	7	REG_RD_DATA, Byte 3							
	8	AUX_RD_DATA, Byte 0							
	9	AUX_RD_DATA, Byte 1							
	10	AUX_RD_DATA, Byte 2							
	11	AUX_RD_DATA, Byte 3							
Diagnostics	12	Module number reporting diagnostic data							
	13	Replace Station	-	Diagnostics Active	-	-	-	-	-
Slot 1 (ref. Byte 12)	14	ERR_PARA	-	-	-	-	-	STS_OFLW	STS_UFLW
	15	-	-	-	-	DIA_DO3	DIA_DO2	DIA_DO1	DIA_DO0
	16	-	-	-	-	-	-	-	-
	17	-	-	-	-	-	-	-	-
	18	-	-	-	-	-	-	-	-
	19	-	-	-	-	-	-	-	-
	20	-	-	-	-	-	-	-	-
	21	-	-	-	-	-	-	-	
OUTPUT	BYTE	Bit 7	Bit 6	Bit 5	Bit 4	Bit 3	Bit 2	Bit 1	Bit 0
Control Bytes	0	DO3	DO2	DO1	DO0	-	-	-	GATE
	1	-	SYNC_REQ	-	-	-	-	-	RES_STS
Communication	2	REG_WR	REG_WR_ADR						
	3	REG_RD_ADR							
User Data	4	REG_WR_DATA, Byte 0							
	5	REG_WR_DATA, Byte 1							
	6	REG_WR_DATA, Byte 2							
	7	REG_WR_DATA, Byte 3							

Count Direction: 0 = Up, 1 = Down

SYNC_AKN: Encoder not synchronized with zero-position

ERR_PARA: Faulty/inconsistent parameter data

STS_UFLW: Counter value below lower limit of counter range

STS_OFLW: Counter value exceeded upper limit of counter range

STS_ZC: Counter value crossed zero value

REG_WR_AKN: Register contents updated

REG_WR_ACCEPT: REG_WR_ADR valid

REG_ACT_RD_ADR: Address of actually read input register

REG_RD_ABORT: REG_RD_ADR error

REG_RD_DATA: Content of the register selected by REG_RD_ADR, if RD_ABORT does not equal 1

AUX_RD_DATA: Content of the register which has been defined via parameter byte 14

GATE: Counter active, depending on parameter Gate function

RES_STS: During the change from 0 to 1 the counter status bits (STS_UFLW and STS_OFLW) are reset

SYNC_REQ: Synchronization request

REG_WR_ADR: Address of the register which has to be written with REG_WR_DATA

REG_WR: Write REG_WR_DATA to REG_WR_ADR

REG_RD_ADR: Address of the register which has to be read

REG_WR_DATA: Value which has to be written to the register defined via REG_WR_ADR

DIA_DOx: Diagnostics pending for DOx

NOTE: Digital Inputs and Outputs 0-2 are not accessible via physical connections on BL compact stations.

Modbus® TCP Register Mapping

	REG	Bit 15	Bit 14	Bit 13	Bit 12	Bit 11	Bit 10	Bit 9	Bit 8	Bit 7	Bit 6	Bit 5	Bit 4	Bit 3	Bit 2	Bit 1	Bit 0		
Inputs (RO)	0x0000	ERR PARA	SYNC AKN	-	-	-	-	-	CNT Direc- tion	-	A	B	Z	DI3	DI2	DI1	DI0		
	0x0001	REG RD ABORT	REG_ACT_RD_ADR							REG WR ACCEPT	REG WR AKN	-	-	-	STS ZC	STS OFLW	STS UFLW		
	0x0002 ... 0x0003	REG_RD_DATA (2 Words)																	
	0x0004 ... 0x0005	AUX_RD_DATA (2 Words)																	
	Status (RO)	0x0006	-	FCE	-	-	CFG	COM	VI low	-	VO low	-	-	-	-	-	-	-	DIA
Diag. (RO)	0x0007	-	-	-	-	-	-	-	-	-	-	-	-	-	-	-	-	S1 DIA	
Outputs (RW)	0x0800	-	SYNC REQ	-	-	-	-	-	RES STS	DO3	DO2	DO1	DO0	-	-	-	-	GATE	
	0x0801	REG_RD_ADR							REG WR	REG_WR_ADR									
	0x0802 ... 0x0803	REG_WR_DATA (2 Words)																	
I/O Diag. (RO)	0xA000	-	-	-	-	SC- DO3	SC- DO2	SC- DO1	SC- DO0	PRM	-	-	-	-	-	-	-	OF	UF

PROFINET® Process Data

	BYTE	Bit 7	Bit 6	Bit 5	Bit 4	Bit 3	Bit 2	Bit 1	Bit 0	
Inputs	11	-	A	B	Z	DI3	DI2	DI1	DI0	
	10	ERR_PARA	SYNC_AKN	-	-	-	-	-	Count Direc- tion	
	9	REG_WR_ACCEPT	REG_WR_AKN	-	-	-	STS_ZC	STS_OFLW	STS_UFLW	
	8	REG_RD_ABORT	REG_ACT_RD_ADR							
	7	REG_RD_DATA, Byte 0								
	6	REG_RD_DATA, Byte 1								
	5	REG_RD_DATA, Byte 2								
	4	REG_RD_DATA, Byte 3								
	3	AUX_RD_DATA, Byte 0								
	2	AUX_RD_DATA, Byte 1								
1	AUX_RD_DATA, Byte 2									
0	AUX_RD_DATA, Byte 3									
Outputs	7	DO3	DO2	DO1	DO0	-	-	-	GATE	
	6	-	SYNC_REQ	-	-	-	-	-	RES_STS	
	5	REG_WR	REG_WR_ADR							
	4	REG_RD_ADR								
	3	REG_WR_DATA, Byte 0								
	2	REG_WR_DATA, Byte 1								
	1	REG_WR_DATA, Byte 2								
	0	REG_WR_DATA, Byte 3								