

BL Compact Fieldbus Station for EtherCAT

8 Digital NPN Inputs

BLCEC-4M12MT-8DI-N

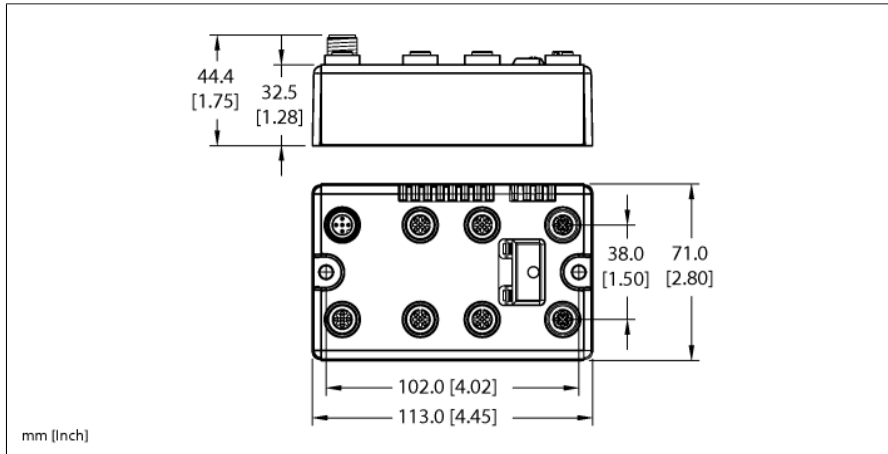

ID	6811631
Nominal system voltage	24 VDC
System power supply	Via auxiliary power
Voltage supply connection	2 x M12, 5-pin
Admissible range V_i	11...30 VDC
Nominal current V_i	101 mA
Max. current V_i	1 A
Fieldbus transmission rate	100 Mbps
Fieldbus address range	0 x 00 (automatic assignment) 0 x 01...0 x FF (fixed assignment)
Fieldbus addressing	2 hexadecimally coded rotary switches
Fieldbus connection technology	2 x M12
	4-pole, D-coded
Service interface	Ethernet
Digital inputs	
Input type	NPN
Type of input diagnostics	Group diagnostics
Sensor supply (V_{sens})	24 VDC
Low-level signal voltage	7...30 VDC
High level signal voltage	< 5 VDC
Low level signal current	< 1.2 mA
High level signal current	> 1.5 mA
Input delay	0.25 ms

- On-machine Compact fieldbus I/O block
- EtherCAT™ slave
- Integrated Ethernet Switch
- Two 4-pole M12, D-coded, connectors for fieldbus connection
- Auto and Fixed addressing
- IP67, IP69K
- M12 I/O connectors
- LEDs indicating status and diagnostics
- Electronics galvanically separated from the field level via optocouplers
- 8 digital NPN inputs, 24 VDC

Dimensions	113 x 71 x 32.5 mm
Mounting	2 × 5.4 mm diameter holes, 1.7 Nm torque
Weight	390 ± 20 g
Housing material	Glass-filled nylon, nickel plated brass connectors
Housing color	Black
Material screw	Nickel-plated brass
Material label	Polyester with polycarbonate overlay
Ground label material	Nickel plated brass
Protection class	IP67 IP69K
Ambient temperature	-40...+70 °C
Storage temperature	-40...+85 °C
Relative humidity	15 to 95% (non-condensing)
Vibration test	Acc. to IEC 61131-2
- up to 20 g (at 10 up to 150 Hz)	For mounting on base plate or machinery
Shock test	according to IEC 61131-2
Electromagnetic compatibility	Acc. to IEC 61131-2
MTTF	110 years
MTTF note	acc. to SN 29500 (Ed. 99) 20 °C
Approvals and certificates	CE, cULus

Pinning and wiring diagram

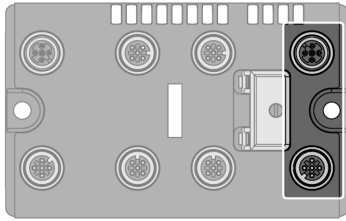

EtherCAT

Fieldbus cable (IP67 example): RSSD RSSD 441-2M ID number U-02482 or RSSD-RSSD-441-2M/S2174 ID number 6914218

Pin Assignment (M12, D-code)

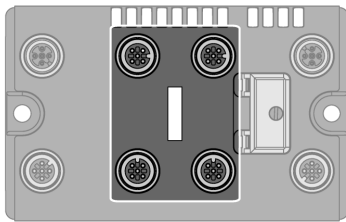
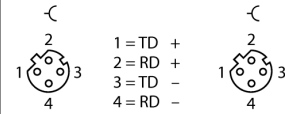

Digital Inputs

Extension cable (example): RK 4.4T-2-RS 4.4T ident-no. U2445 or RKC4.4T-2-RSC4.4T/TEL ident-no. 6625208

Pin Assignment

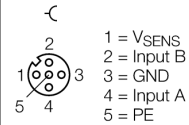

Wiring Diagram for Dual Input Sensor

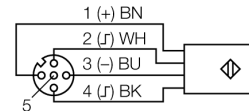

Wiring Diagram for 2 Sensors

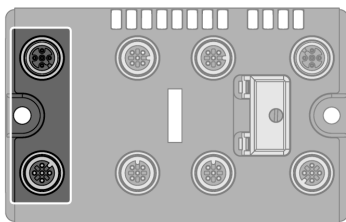
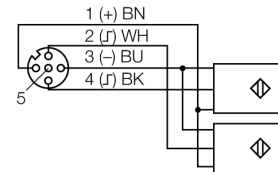

Auxiliary Power

Extension cable (example): RKC 4.4T-2-RSC 4.4T ident-no. U5264 or RKC4.4T-2-RSC4.4T/TEL ident-no. 6625208

Pin Assignment

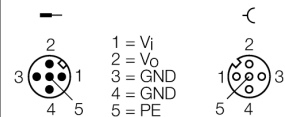

Station LED status

LED	Color	Status	Description
IOs		OFF	No power
	RED	ON	Low power or station error
	RED	FLASHING (1 Hz)	I/O module configuration error
	RED	FLASHING (4 Hz)	No I/O module bus communication
	GREEN	ON	Station ok
	GREEN	FLASHING	Force mode active
LNK/ACT		OFF	Port Closed, No Link, No Activity
	GREEN	ON	Port Open, Link Established, No Activity
	GREEN	FLICKERING	Port Open, Link Established, Activity Present
RUN		OFF	Device is in state INIT
	GREEN	BLINKING	Device is in state PRE-OPERATIONAL
	GREEN	SINGLE FLASH	Device is in state SAFE-OPERATIONAL
	GREEN	ON	Device is in state OPERATIONAL
	GREEN	FLICKERING	Device is in state BOOTSTRAP
ERR	RED	ON	Application controller not responding
	RED	DOUBLE FLASH	Sync Manager Watchdog timeout
	RED	SINGLE FLASH	State changes from Op to SafeOpError (synchronization error)
	RED	BLINKING	State change not possible (invalid register/object settings/hardware config.)
	RED	OFF	No EtherCAT comm errors

I/O Data Map

INPUT	BYTE	Bit 7	Bit 6	Bit 5	Bit 4	Bit 3	Bit 2	Bit 1	Bit 0
	0	DI 1 ₇	DI 1 ₆	DI 1 ₅	DI 1 ₄	DI 1 ₃	DI 1 ₂	DI 1 ₁	DI 1 ₀
	1	-	-	-	-	-	-	-	-