

BL compact™ fieldbus station for DeviceNet™

4 Analog Inputs for Current or Voltage and 4 Analog Outputs for Voltage

BLCDN-4M12S-4AI4AO-VI

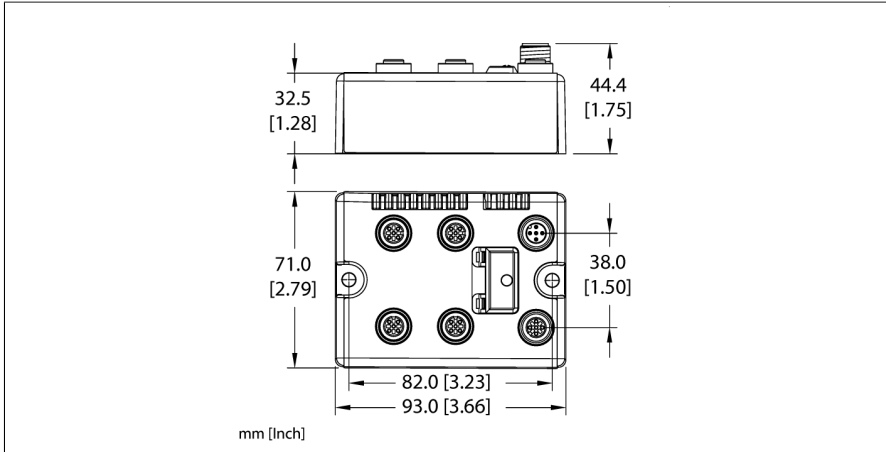

ID	6811056
Nominal system voltage	24 VDC
System power supply	Via DeviceNet
Admissible range V+	11...30 VDC
Nominal current V+	130 mA
Max. current V+	4 A
Fieldbus transmission rate	125/250/500 kbps
Adjustment transmission rate	Automatic detection
Fieldbus address range	0...63 64...80 (MacID programmable) 81...99 (manufacturer specific)
Fieldbus addressing	2 decimally coded rotary switches
Fieldbus connection technology	2 × M12
Fieldbus termination	5-pole external
Service interface	RS232 interface
Vendor ID	48
Product type	12
Product code	11056
Analog inputs	from 4AI4AO-VI
Operating modes	0/4 ... 20 mA or -10/0 ... 10 VDC
Type of input diagnostics	Channel diagnostics
Sensor supply	24 VDC, 1 amp max.
Input resistance	Current: < 0.065 KΩ, Voltage: < 225 KΩ
Maximum limiting frequency analog	< 20 Hz
Basic fault limit at 23 °C	< 0.3 %
Repeatability	< 0.05 %
Temperature coefficient	< 300 ppm / °C of full scale
Resolution	16 Bit
Measuring principle	Sigma Delta
Measurement display	16 bit signed integer 12 bit full range left-justified

- On-machine Compact fieldbus I/O block
- DeviceNet™ slave
- 125 / 250 / 500 kbps
- Two 5-pole M12 connectors for fieldbus connection
- 2 rotary switches for node address
- IP67, IP69K
- M12 I/O connectors
- LEDs indicating status and diagnostics
- Electronics galvanically separated from the field level via optocouplers
- 4 analog inputs for current or voltage
- 0/4...20 mA or -10/0...+10 VDC (selectable per channel)
- 4 analog voltage outputs
- -10/0...+10 VDC

Analog outputs	from 4AI4AO-VI
Operating modes	-10/0 ... 10 V
Type of output diagnostics	Channel diagnostics
Sensor supply	24 VDC, 250 mA per channel
Load resistance, resistive	> 1 k Ω
Load resistance, capacitive	< 1 μ F
Transmission frequency	< 100 Hz
Basic fault limit at 23 °C	< 0.3 %
Repeat accuracy	< 0.05 %
Temperature coefficient	< 300 ppm/°C of full scale
Resolution	16 bit
Measured-value display	16 bit signed integer
	12 bit full range left-justified
<hr/>	
Dimensions	93 x 71 x 32.5 mm
Mounting	2 x 5.4 mm diameter holes, 1.7 Nm torque
Weight	320 \pm 20 g
Housing material	Glass-filled nylon, nickel plated brass connectors
Housing color	Black
Material screw	Nickel-plated brass
Material label	Polyester with polycarbonate overlay
Ground label material	Nickel plated brass
Protection class	IP67 IP69K
Ambient temperature	-40...+70 °C
Storage temperature	-40...+85 °C
Relative humidity	15 to 95% (non-condensing)
Vibration test	Acc. to IEC 61131-2
- up to 20 g (at 10 up to 150 Hz)	For mounting on base plate or machinery
Shock test	according to IEC 61131-2
Electromagnetic compatibility	Acc. to IEC 61131-2
Approvals and certificates	CE, cULus

Pinning and wiring diagram

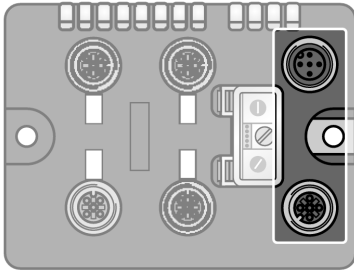

DeviceNet

Fieldbus cable (example): RSC RKC 572-2M ident-no. U0323 or RSC-RKC572-2M ident-no. 6603629

Pin Assignment

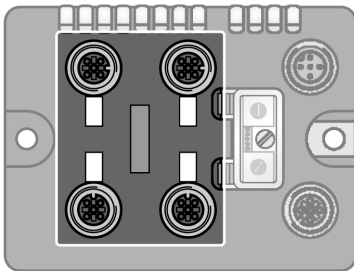
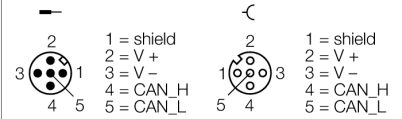

Analog Inputs and Outputs

Extension cable (example): RK 4.5T-2-RS 4.5T/S653 ident-no. U2187-09 or RKC4.5T-2-RSC4.5T/TEL ident-no. 6625212

Pin Assignment

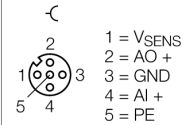

2-wire Technology (Current)

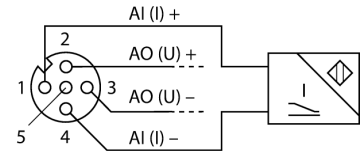

2-wire Technology (Voltage)

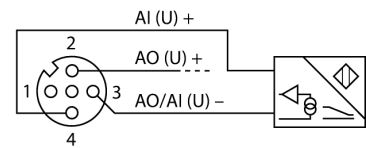

3-wire Technology

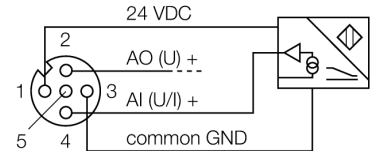

4-wire Technology

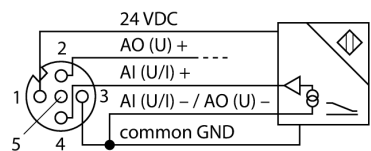

4-wire Technology (External Power)

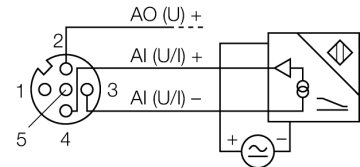

Station LED status

LED	Color	Status	Description
IOs		OFF	No power
	RED	ON	Low power or station error
	RED	FLASHING (1 Hz)	I/O module configuration error
	RED	FLASHING (4 Hz)	No I/O module bus communication
	GREEN	ON	Station ok
	GREEN	FLASHING	Force mode active
MNS		OFF	No connection
	GREEN	ON	Connection established
	GREEN	FLASHING (1 Hz)	No connection established, device OK
	RED	ON	Duplicate MAC-ID
	RED	FLASHING	Connection time out
IO	GREEN	ON	I/O active
	GREEN	FLASHING (1 Hz)	One or more I/O in Idle State
	RED	ON	One or more I/O error
	RED	FLASHING	One or more I/O in Faulted State

I/O LED status

LED	Color	Status	Description
D *		OFF	No diagnostics active
	RED	ON	Station error/ module bus communication failure
	RED	FLASHING (0.5Hz)	Diagnostics active
AI channels 0...3		OFF	Channel inactive
	GREEN	ON	Channel active
	GREEN	FLASHING (0.5 Hz)	Underflow diagnostics
	GREEN	FLASHING (4 Hz)	Overflow diagnostics
AO channels 4...7			Not connected (The analog outputs do not have a LED)

* D LED also indicates gateway diagnostics

I/O & Diagnostic Data Map

INPUT	BYTE	Bit 7	Bit 6	Bit 5	Bit 4	Bit 3	Bit 2	Bit 1	Bit 0
AI 1 ₀	0	AI 1 ₀ LSB							
	1	AI 1 ₀ MSB							
AI 1 ₁	2	AI 1 ₁ LSB							
	3	AI 1 ₁ MSB							
AI 1 ₂	4	AI 1 ₂ LSB							
	5	AI 1 ₂ MSB							
AI 1 ₃	6	AI 1 ₃ LSB							
	7	AI 1 ₃ MSB							
Diagnostics	8	Module number reporting diagnostic data							
	9	Replace Station	-	Diagnostics Active	-	-	-	-	-
Slot 1 (ref. Byte 8)	10	Hardware Failure	-	-	-	AI 1 ₀ Overflow/Underflow	-	Wire Break AI 1 ₀ (4...20 mA range only)	Range Error AI 1 ₀
	11	Hardware Failure	-	-	-	AO 1 ₀ Overflow/Underflow	-	-	Range Error AO 1 ₀
	12	Hardware Failure	-	-	-	AI 1 ₁ Overflow/Underflow	-	Wire Break AI 1 ₁ (4...20 mA range only)	Range Error AI 1 ₁
	13	Hardware Failure	-	-	-	AO 1 ₁ Overflow/Underflow	-	-	Range Error AO 1 ₁
	14	Hardware Failure	-	-	-	AI 1 ₂ Overflow/Underflow	-	Wire Break AI 1 ₂ (4...20 mA range only)	Range Error AI 1 ₂
	15	Hardware Failure	-	-	-	AO 1 ₂ Overflow/Underflow	-	-	Range Error AO 1 ₂
	16	Hardware Failure	-	-	-	AI 1 ₃ Overflow/Underflow	-	Wire Break AI 1 ₃	Range Error AI 1 ₃
	17	Hardware Failure	-	-	-	AO 1 ₃ Overflow/Underflow	-	-	Range Error AO 1 ₃
OUTPUT	BYTE	Bit 7	Bit 6	Bit 5	Bit 4	Bit 3	Bit 2	Bit 1	Bit 0
AO 1 ₀	0	AO 1 ₀ LSB							
	1	AO 1 ₀ MSB							
AO 1 ₁	2	AO 1 ₁ LSB							
	3	AO 1 ₁ MSB							
AO 1 ₂	4	AO 1 ₂ LSB							
	5	AO 1 ₂ MSB							
AO 1 ₃	6	AO 1 ₃ LSB							
	7	AO 1 ₃ MSB							