

BL compact™ fieldbus station for CANopen

4 Analog Inputs for Current or Voltage

BLCCO-4M12S-4AI-VI

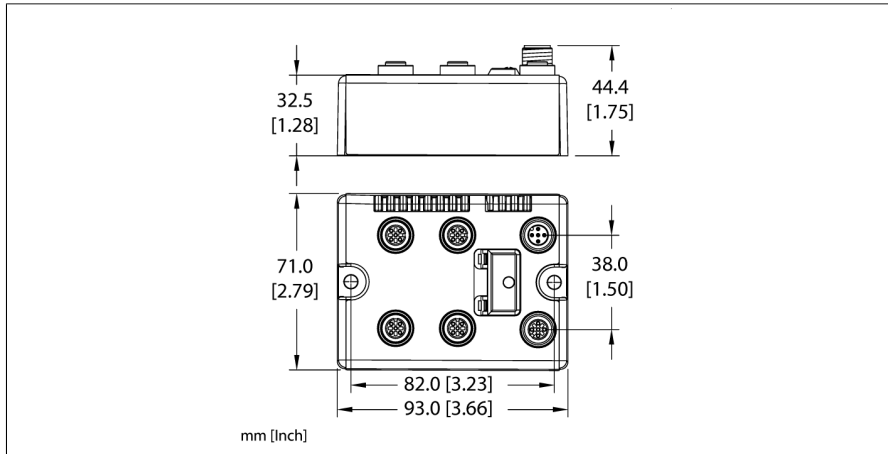

ID	6811301
Nominal system voltage	24 VDC
System power supply	Via CANopen
Admissible range V+	11...30 VDC
Nominal current V+	42 mA
Max. current V+	4 A
Fieldbus transmission rate	10 kbps ...1 Mbps
Adjustment transmission rate	Automatic detection
Fieldbus address range	1...99
Fieldbus addressing	2 decimally coded rotary switches
Fieldbus connection technology	2 × M12
Fieldbus termination	5-pole
Service interface	external RS232 interface
Analog inputs	from 4AI-VI
Operating modes	0/4 ... 20 mA or -10/0 ... 10 VDC
Type of input diagnostics	Channel diagnostics
Sensor supply	24 VDC, 1 amp max.
Input resistance	Current: < 0.125 KΩ, Voltage: < 98.5 KΩ
Maximum limiting frequency analog	< 20 Hz
Basic fault limit at 23 °C	< 0.3 %
Repeatability	< 0.05 %
Temperature coefficient	< 300 ppm / °C of full scale
Resolution	16 Bit
Measuring principle	Sigma Delta
Measurement display	16 bit signed integer
	12 bit full range left-justified

- On-machine Compact fieldbus I/O block
- CANopen slave
- 10, 20, 50, 125, 250, 500, 800, or 1000 kbps
- Two 5-pole M12 connectors for fieldbus connection
- 2 rotary switches for node address
- IP67, IP69K
- M12 I/O connectors
- LEDs indicating status and diagnostics
- Electronics galvanically separated from the field level via optocouplers
- 4 analog inputs for current or voltage
- 0/4...20 mA or -10/0...+10 VDC (selectable per channel)

Dimensions	93 x 71 x 32.5 mm
Mounting	2 × 5.4 mm diameter holes, 1.7 Nm torque
Weight	320 ± 20 g
Housing material	Glass-filled nylon, nickel plated brass connectors
Housing color	Black
Material screw	Nickel-plated brass
Material label	Polyester with polycarbonate overlay
Ground label material	Nickel plated brass
Protection class	IP67 IP69K
Ambient temperature	-40...+70 °C
Storage temperature	-40...+85 °C
Relative humidity	15 to 95% (non-condensing)
Vibration test	Acc. to IEC 61131-2
- up to 20 g (at 10 up to 150 Hz)	For mounting on base plate or machinery
Shock test	according to IEC 61131-2
Electromagnetic compatibility	Acc. to IEC 61131-2
Approvals and certificates	CE, cULus

Pinning and wiring diagram

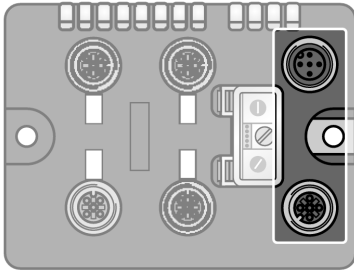

CANopen

Fieldbus cable (example): RSC RKC 572-2M ident-no. U0323 or RSC-RKC572-2M ident-no. 6603629

Pin Assignment

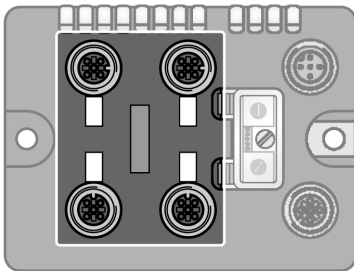
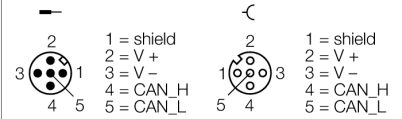

Analog Inputs

Extension cable (example): RK 4.5T-2-RS 4.5T/S653 ident-no. U2187-09 or RKC4.5T-2-RSC4.5T/TEL ident-no. 6625212

Pin Assignment

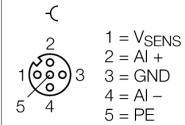

2-wire Technology (Current)

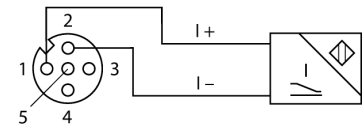

2-wire Technology (Voltage)

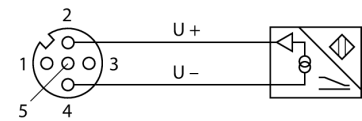

3-wire Technology

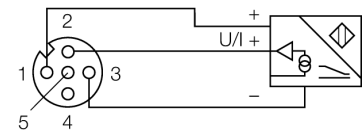

4-wire Technology

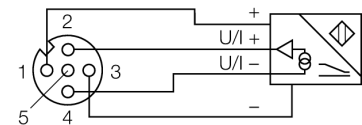

4-wire Technology (External Power)

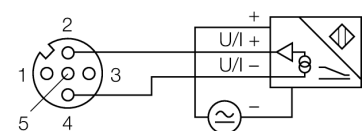

Station LED status

LED	Color	Status	Description
IOs		OFF	No power
	RED	ON	Low power or station error
	RED	FLASHING (1 Hz)	I/O module configuration error
	RED	FLASHING (4 Hz)	No I/O module bus communication
	GREEN	ON	Station ok
	GREEN	FLASHING	Force mode active
ERR	-	OFF	No communication error
	RED	ON	CAN bus communication error
BUS	GREEN	ON	NMT-slave state is „Operational“
	ORANGE	ON	NMT-slave state is „Pre-Operational“
	RED	ON	NMT-slave state is „Stopped“
ERR & BUS	RED (ERR) & GREEN (BUS)	FLASHING (4 Hz)	Searching for the baud rate

I/O LED status

LED	Color	Status	Description
D *		OFF	No diagnostics active
	RED	ON	Station error/ module bus communication failure
	RED	FLASHING (0.5Hz)	Diagnostics active
AI channel 0...3		OFF	Not active
	GREEN	ON	Active
	GREEN	FLASHING (0.5 Hz)	Underflow in measuring range
	GREEN	FLASHING (4 Hz)	Overflow in measuring range

* D LED also indicates gateway diagnostics

I/O Data Map

INPUT	BYTE	Bit 7	Bit 6	Bit 5	Bit 4	Bit 3	Bit 2	Bit 1	Bit 0
AI 1 ₀	0	AI 1 ₀ LSB							
	1	AI 1 ₀ MSB							
AI 1 ₁	2	AI 1 ₁ LSB							
	3	AI 1 ₁ MSB							
AI 1 ₂	4	AI 1 ₂ LSB							
	5	AI 1 ₂ MSB							
AI 1 ₃	6	AI 1 ₃ LSB							
	7	AI 1 ₃ MSB							