

BI4U-EM12EWD-VP6X 12M

Inductive Sensor – For the Food Industry

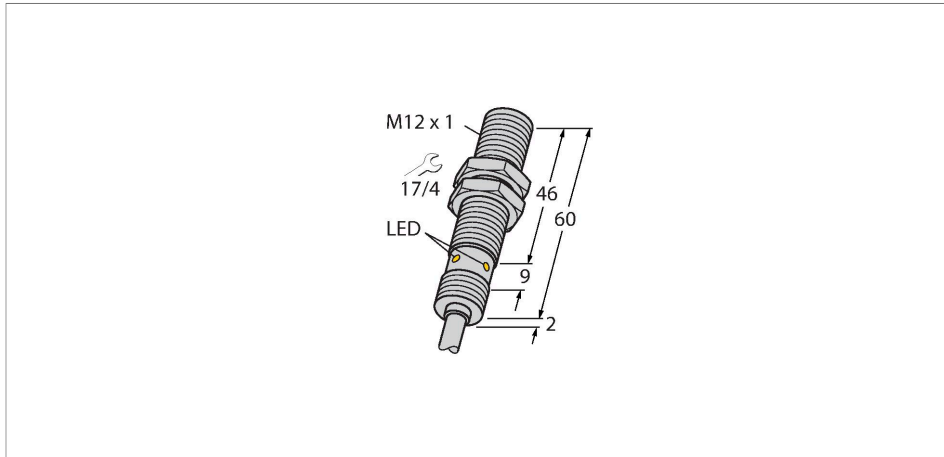

Features

- Threaded barrel, M12 x 1
- Stainless steel, 1.4301
- Front cap made of liquid crystal polymer
- Factor 1 for all metals
- Resistant to magnetic fields
- For temperatures of -40 °C...+100 °C
- High protection class IP69K for harsh environments
- Special double-lip seal
- Protection against all common acidic and alkaline cleaning agents
- Laser engraved label, permanently legible
- DC 4-wire, 10...30 VDC
- Changeover contact, PNP output
- Cable connection

Technical data

Type	BI4U-EM12EWD-VP6X 12M
ID	100000771
General data	
Rated switching distance	4 mm
Mounting conditions	Flush
Secured operating distance	$\leq (0.81 \times S_n)$ mm
Repeat accuracy	≤ 2 % of full scale
Temperature drift	$\leq \pm 10$ %
	$\leq \pm 20$ %, ≤ -25 °C , $\geq +70$ °C
Hysteresis	3...15 %
Electrical data	
Operating voltage U_B	10...30 VDC
Ripple U_{ss}	≤ 10 % U_{Bmax}
DC rated operating current I_e	≤ 200 mA
No-load current	≤ 15 mA
Residual current	≤ 0.1 mA
Isolation test voltage	0.5 kV
Short-circuit protection	yes/Cyclic
Voltage drop at I_e	≤ 1.8 V
Wire break/reverse polarity protection	yes/Complete
Output function	4-wire, Complementary contact, PNP
DC field stability	300 mT
AC field stability	300 mT _{ss}
Switching frequency	3 kHz

Wiring diagram

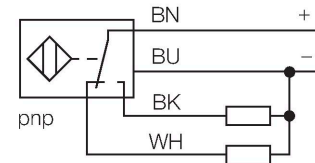

Functional principle

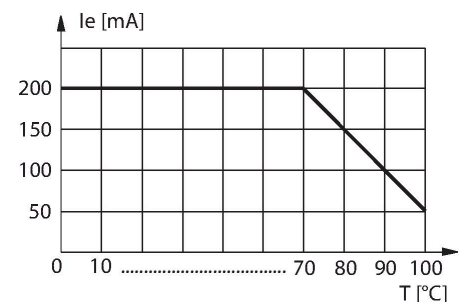

BI4U-EM12EWD-VP6X 12M | 07/26/2024 15:27 | technical changes reserved

Technical data

Mechanical data	
Design	Threaded barrel, M12 x 1
Dimensions	64 mm
Housing material	Stainless steel, 1.4301 (AISI 304)
Active area material	Plastic, LCP
End cap	Plastic, EPTR
Connector housing	PP
Admissible pressure on front cap	≤ 20 bar
Max. tightening torque of housing nut	10 Nm
Electrical connection	Cable
Cable quality	Ø 5.2 mm, Gray, Lif12Y33Y, TPE, 12 m
	Food safe
Core cross-section	4 x 0.25 mm ²
Environmental conditions	
Ambient temperature	-40...+100 °C
Vibration resistance	55 Hz (1 mm)
Shock resistance	30 g (11 ms)
Protection class	IP68 IP69K
MTTF	874 years acc. to SN 29500 (Ed. 99) 40 °C
Switching state	LED, Yellow

Mounting instructions

Mounting instructions/Description

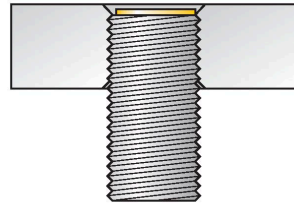

Distance D	24 mm
Distance W	3 x Sn
Distance T	3 x B
Distance S	1.5 x B
Distance G	6 x Sn
Diameter active area B	Ø 12 mm

All flush mountable uprox+ threaded barrel types are also recessed mountable. Safe operation is ensured if the sensor is screwed in by half a turn.

Accessories

MW12

6945003

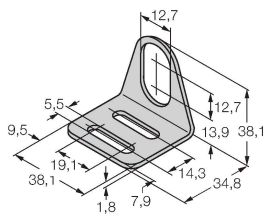

Mounting bracket for threaded barrel sensors; material: Stainless steel A2 1.4301 (AISI 304)

BSS-12

6901321

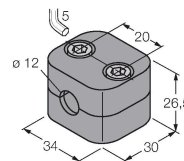

Mounting clamp for smooth and threaded barrel sensors; material: Polypropylene

PN-M12

6905309

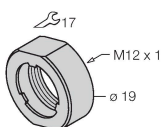

Impact protection nut for M12x1 threaded barrel devices; material: Stainless steel A2 1.4305 (AISI 303)