

# BI2-EG08K-AP6X-V1131/S957-S1367

## Inductive Sensor – With Increased Switching Distance

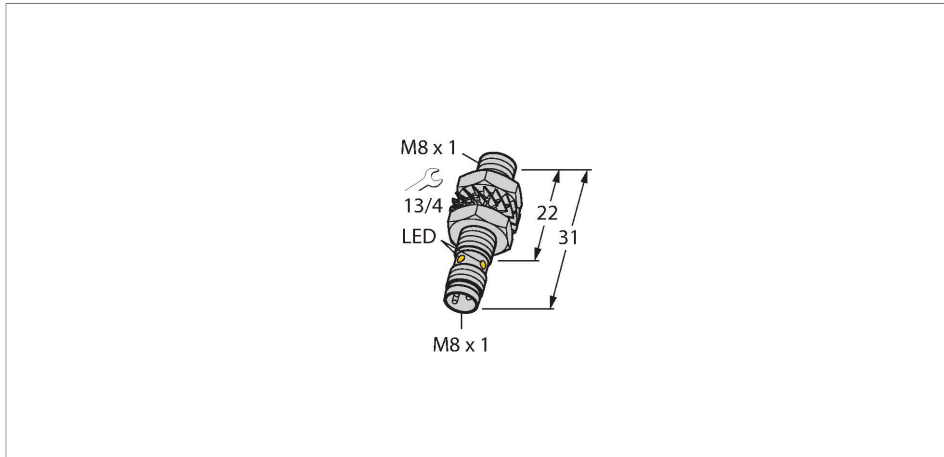

### Features

- Threaded barrel, M8 x 1
- Stainless steel, 1.4427 SO
- Large sensing range
- DC 3-wire, 10...30 VDC
- NO contact, PNP output
- M8 x 1 male connector

### Wiring diagram

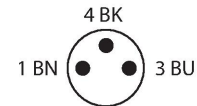
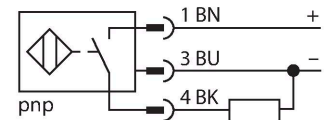

### Technical data

Type	BI2-EG08K-AP6X-V1131/S957-S1367
Ident. no.	100023373
Special version	Old design before 2019, Full flush mounting
Rated switching distance	2 mm
Mounting conditions	Flush
Secured operating distance	$\leq (0.81 \times S_n)$ mm
Correction factors	St37 = 1; Al = 0.3; stainless steel = 0.7; Ms = 0.4
Repeat accuracy	$\leq 2$ % of full scale
Temperature drift	$\leq \pm 10$ %
Hysteresis	3...15 %
Ambient temperature	-25...+70 °C
Operating voltage	10...30 VDC
Residual ripple	$\leq 10$ % $U_{ss}$
DC rated operational current	$\leq 150$ mA
No-load current	$\leq 15$ mA
Residual current	$\leq 0.1$ mA
Isolation test voltage	$\leq 0.5$ kV
Short-circuit protection	yes / Cyclic
Voltage drop at $I_o$	$\leq 1.8$ V
Wire breakage/Reverse polarity protection	yes / Complete
Output function	3-wire, NO contact, PNP
Switching frequency	3 kHz

### Functional principle

Inductive sensors detect metal objects contactless and wear-free. For this, they use a high-frequency electromagnetic AC field that interacts with the target. Inductive sensors generate this field via an RLC circuit with a ferrite coil.

## Technical data

Design	Threaded barrel, M8 × 1
Dimensions	31 mm
Housing material	Stainless steel, 1.4427 SO
Active area material	Plastic, PA12-GF20
Max. tightening torque housing nut	5 Nm
Electrical connection	Connector, M8 × 1
Vibration resistance	55 Hz (1 mm)
Shock resistance	30 g (11 ms)
Protection class	IP67
MTTF	2283 years acc. to SN 29500 (Ed. 99) 40 °C
Switching state	LED, Yellow

## Mounting instructions

### Mounting instructions/Description



Distance D	2 x B
Distance W	3 x Sn
Distance T	3 x B
Distance S	1.5 x B
Distance G	6 x Sn
Diameter active area B	Ø 8 mm

## Accessories

BST-08B

6947210

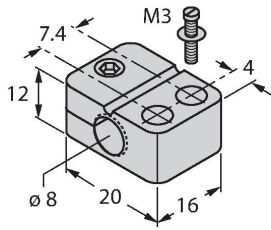

Mounting clamp for threaded barrel sensors, with dead-stop; material: PA6

QM-08

6945100

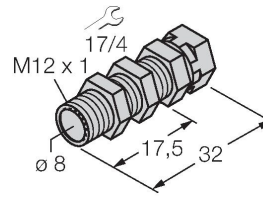

Quick-mount bracket with dead-stop, chrome-plated brass, male thread M12 x 1. Note: The switching distance of proximity switches may be reduced through the use of quick-mount brackets.

MW-08

6945008

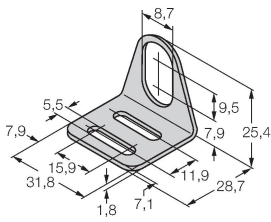

Mounting bracket for threaded barrel sensors; material: Stainless steel A2 1.4301 (AISI 304)

BSS-08

6901322

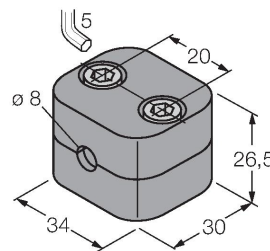

Mounting clamp for smooth and threaded barrel sensors; material: Polypropylene

MBS80

69479

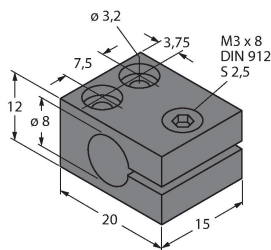

Mounting clamp for smooth barrel sensors; mounting block material: Anodized aluminum

## Wiring accessories

Dimension drawing

Type

Ident. no.

PKG3M-2/TEL

6625385

Connection cable, female M8, straight, 3-pin, stainless steel coupling nut, cable length: 2 m, sheath material: PVC, black; cULus approval; other cable lengths and qualities available, see [www.turck.com](http://www.turck.com)

